

Appendix D

Street Frontage

Height and

Setbacks

2016

Contents

1	Introduction	5	4	Conclusions and recommendations	53
1.1	Purpose of this study	7	4.1	Conclusions: Discussion	54
1.2	Methodology	7	4.2	Recommendations	56
2	Existing situation	9	5	Example SVF tests	59
2.1	Existing Controls	10			
2.1.1	Street Frontage Height and Setback	10			
2.1.2	Side and Rear Setbacks	11			
2.2	Environmental Conditions	14			
2.2.1	Wind	16			
2.2.2	Sunlight and daylight	20			
2.2.3	Scale	32			
2.3	Mapping Street Frontage Height and Setback Conditions	36			
3	Analysis and issues	41			
3.1	Street Frontage Height and Setbacks Controls	42			
3.2	Setbacks and Separations	44			
3.3	Capacity for Growth	46			
3.4	Balancing Amenity and Capacity	46			
3.5	Wind	46			
3.6	Daylight	48			

1

Introduction

1.1

Purpose of this study

General built form controls of Street Frontage Height (SFH), setbacks, separation and massing are all designed to manage amenity in the urban environment (sunlight, daylight and wind), as experienced by people in streets and other public places.

General built form controls affect capacity on any site because they reduce the built form beneath the height limit, defining a maximum permissible envelope. Currently in Central Sydney, these controls are not linked to the FSR for any site, though these controls, together with height, define the maximum amount of floor space any site can achieve.

The purpose of this study is to review the existing Street Frontage Height and setback controls applying to the city for efficacy, considering:

- Existing condition of the city
- Likely development outcomes as a result of the growth strategy for Central Sydney.

1.2

Methodology

The methodology has been to:

- Review the intent and objectives for built form in Central Sydney, other than height, as described by the current framework.
- Examine the existing amenity conditions in Central Sydney including wind, daylight and scale.
- Model the existing city form.
- Analyse the current controls in terms of their impact on overall city form, amenity and their efficacy.
- Review the impact of general built form controls on capacity and the significance of the controls in balancing amenity with growth.
- Provide recommendations for revisions to the framework that balance growth and capacity with amenity in Central Sydney.

2

Existing situation

The existing situation comprises the existing controls, environmental conditions and built form. These will be addressed sequentially through this section.

2.1 Existing Controls

General Built Form controls for Central Sydney promote a street wall building or podium and tower built form typology and consist of:

- Street Frontage Height and Street Setback
- Side and Rear Setbacks
- Separations
- Built Form massing controls

The preferred built form typology for Central Sydney is a predominant street wall building (or podium form), with towers set back above. This configuration of form allows tall buildings to exist whilst managing many of their impacts on the amenity of the public domain, and surrounding development.

2.1.1 Street Frontage Height and Setback

Street Frontage Height and Setback controls apply to new development in order to create the preferred built form typology. The planning framework sets the permissible extent of setback and the appropriate range of Street Frontage Heights in order to achieve amenity objectives in the public domain.

Street Frontage Height and Setbacks of new development are controlled in order to:

- Manage the general character and amenity of streets;
- Maintain light, air and human scale within streets;
- Mitigate wind impacts of towers;
- Avoid an urban canyon effect (contributing to urban heat island) and stagnation of polluted air; and
- Facilitate separation between towers.

These controls work in concert to make the street a comfortable and interesting environment for people by addressing considerations of:

- Sun – to allow day light into the street and create sunny patches for people to gather or linger;
- Wind – to protect the street environment from wind;
- Sky – to protect open views to the sky (in the distance and above – by shifting the tower back, which would otherwise close your view to the sky above in perspective when looking up);
- Scale – to promote a ‘human scale’ (perceived scale of buildings); and
- Character – to protect special areas where there is a common urban form that contributes to the identity and diversity of the city’s urban experience.

The current 2012 DCP controls have been largely carried over from the 1996 DCP. A summary of the current controls follows:

Street Frontage Height Controls

SFH controls between 20m-45m (refer to D_01) are based on the predominant existing condition of buildings in the city, and the following considerations:

- Most streets are up to 20m wide;
- A maximum SFH of 45m allows small sites to achieve base floor space without seriously compromising amenity factors in the street (daylight, skyview, scale);
- 20m SFH is considered minimum for good definition of streets and public space;
- 45m and above SFH begins to obscure/limit skyviews and the built form feels oppressive for pedestrians; and
- Street Frontage Heights of new buildings adjacent to heritage items must be set at the same height as the adjacent heritage item.

Setback Controls

Setback controls are set at a dimension intended to reinforce the street wall as the dominant form defining the street, to let light and air into the street and to achieve adequate separation between buildings for internal amenity purposes. The following considerations are noted:

- Assuming the majority of streets are approximately 20m wide, a setback of 10m is preferred to effectively double the perceived width of the street and achieve adequate separations between towers;
- An elevational weighted average of 8m setback is permitted, with an absolute minimum setback at any point of 6m (refer to D_05);
- The weighted average setback can be reduced on secondary or minor pedestrian streets;
- The weighted average setback can not be reduced on north-south streets (refer to D_06 and D_07);
- New buildings above a heritage item must provide a minimum 10m setback (refer to D_04); and
- Setbacks to laneways are 6m, measured from the centreline of the road.

Special controls for Street Frontage Height and setbacks apply in Special character Areas in order to reinforce an existing character and urban form that is distinctive and different, usually informed by historical elements in the built form and urban structure. These controls have been reviewed in Appendix E.

A combined street setbacks map is shown at D_08.

2.1.2 Side and Rear Setbacks

Building separations are largely managed through setbacks from side and rear boundaries. For residential buildings, separation are supported by SEPP65 and the Apartment Design Guide. Setback requirements do not take into consideration the use of the building on the adjacent property. In general, any building face with windows is required to be setback from the boundary as follows:

- For commercial buildings, any wall with windows must be set back from the boundary by 3m. Any wall without windows is not required to be set back (refer to D_02).
- For residential buildings, any walls with windows are required to be set back by 6m (below 45m) or 12m (above 45m). Walls without windows are not required to be set back (refer to D_03). SEPP 65 and the ADG set the standard, and provide more detail.

D_01

Existing Controls Sydney DCP 2012

Street Frontage Heights

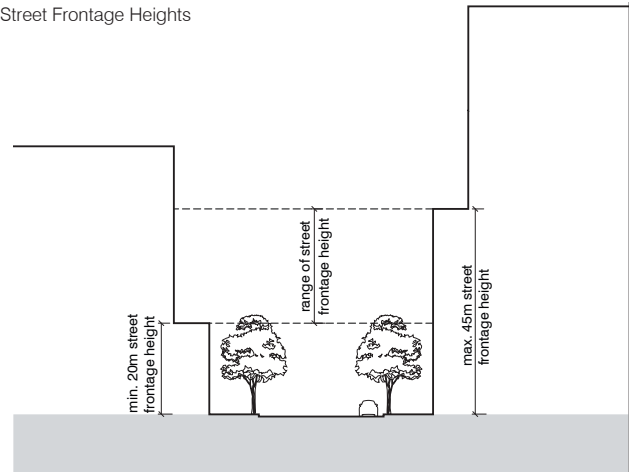

D_02

Setbacks from Side and Rear Boundaries

Commercial Buildings above 45m

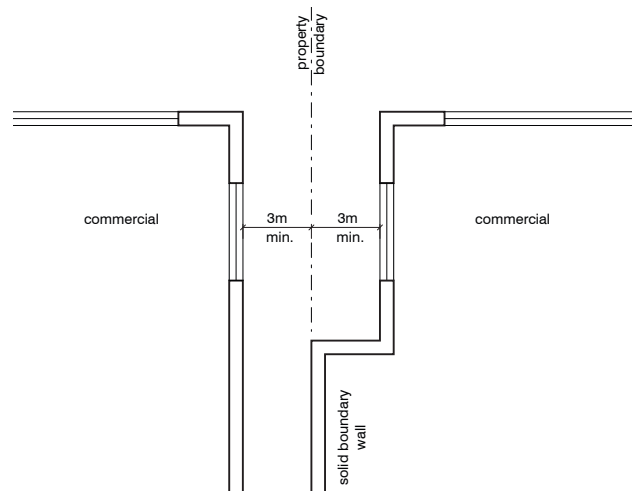

D_03

Setbacks from Side and Rear Boundaries

Commercial and residential Buildings

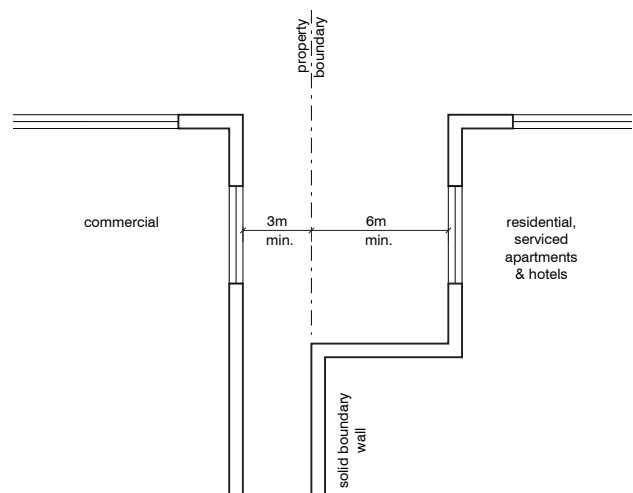

D_04

Existing Controls Sydney DCP 2012
 Minimum setback above a heritage item

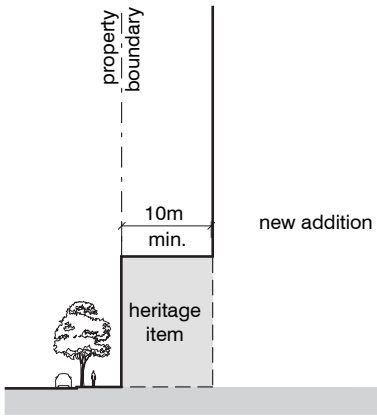

D_05

Existing Controls Sydney DCP 2012
 Front Setbacks

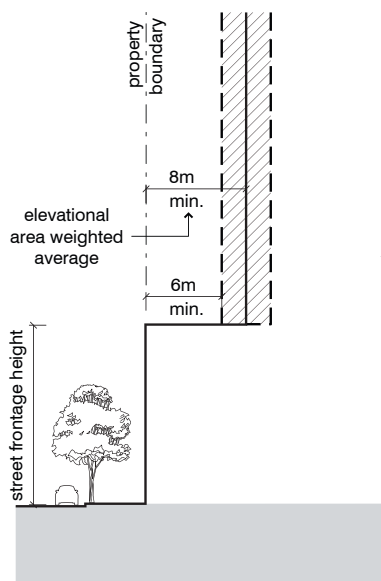
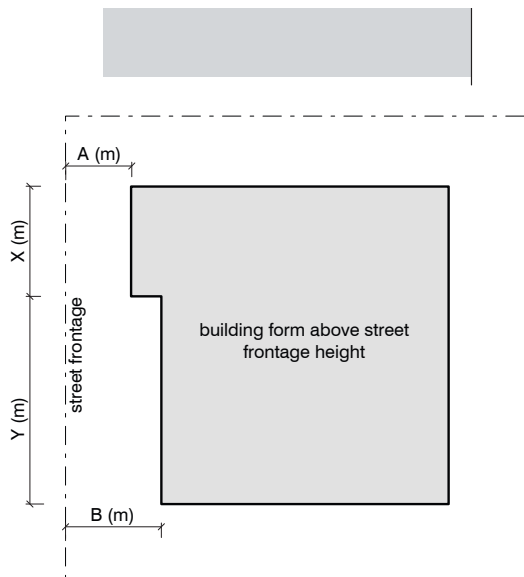

D_06

Existing Controls Sydney DCP 2012
 Front setbacks on corner sites

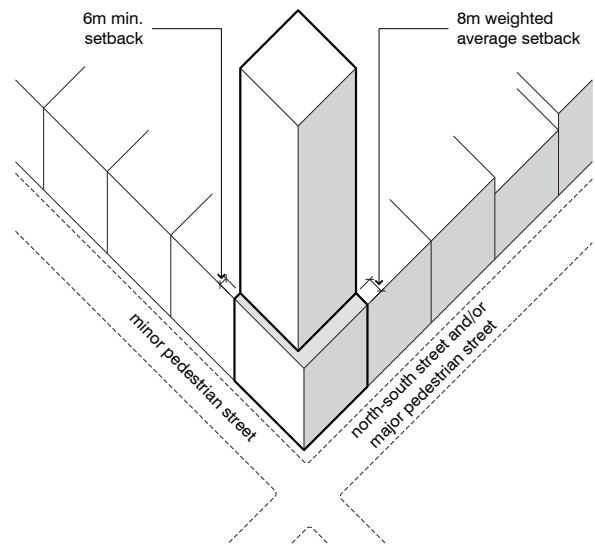

D_07

Existing Controls Sydney DCP 2012
 Front setbacks on corner sites with a laneway

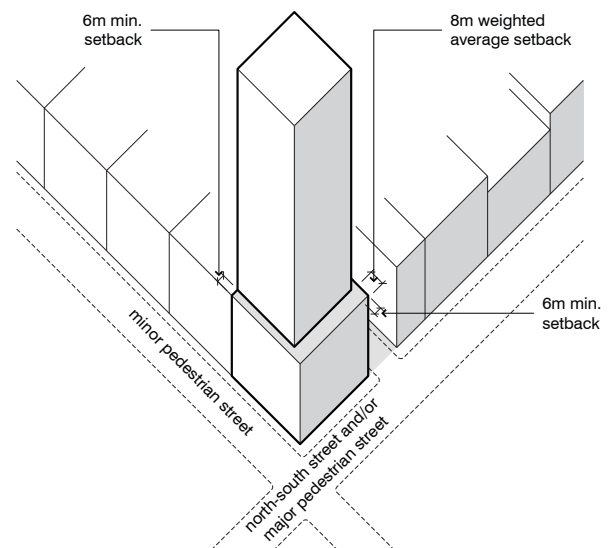

D_08

Existing Street Setback Controls and
Special character Area Setbacks

- 15m
- 25m
- 30m
- 35m
- 45m
- 55m
- 80m
- SCA

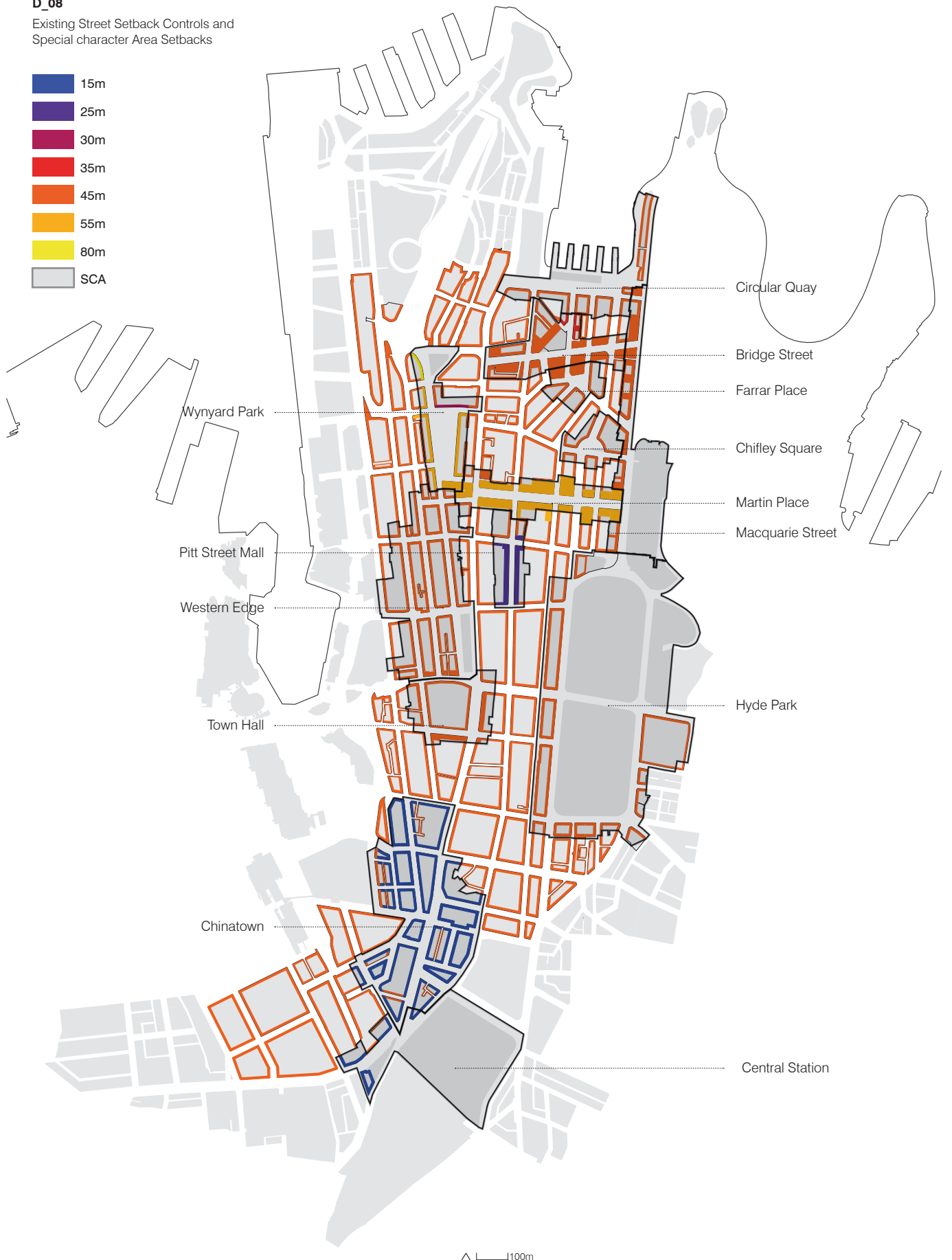

100m

2.2

Environmental Conditions

Access to detailed spatial information of the city enables testing of assumptions behind the existing controls. It also tests efficacy of the controls in achieving their objectives.

Streets in Central Sydney can be narrow (refer to D_09), dark, windy and sometimes uncomfortable for pedestrians. This is a difficult challenge in Central Sydney, where:

- The street network is aligned in a north-south, east-west, grid channelling unpleasant westerly and southerly winds;
- The streets are relatively narrow, and development is tall;
- The edges of the street network are open, terminating in low lying areas – parks, harbour and conservation areas – when wind hits the city it is funnelled into the streets;
- Our geographic location entails that the prevailing winds are aligned with our street network;
- Direct sunlight to streets is limited in winter (particularly east-west streets) discussed further below; and
- Prevailing built form patterns of quite tall buildings, results in poor daylight in many narrower streets.

These are the constraints that cannot be changed. The City's form must adapt to make streets as comfortable as possible for people. The objectives of existing controls, outlined above, remain relevant.

D_09

Street Widths

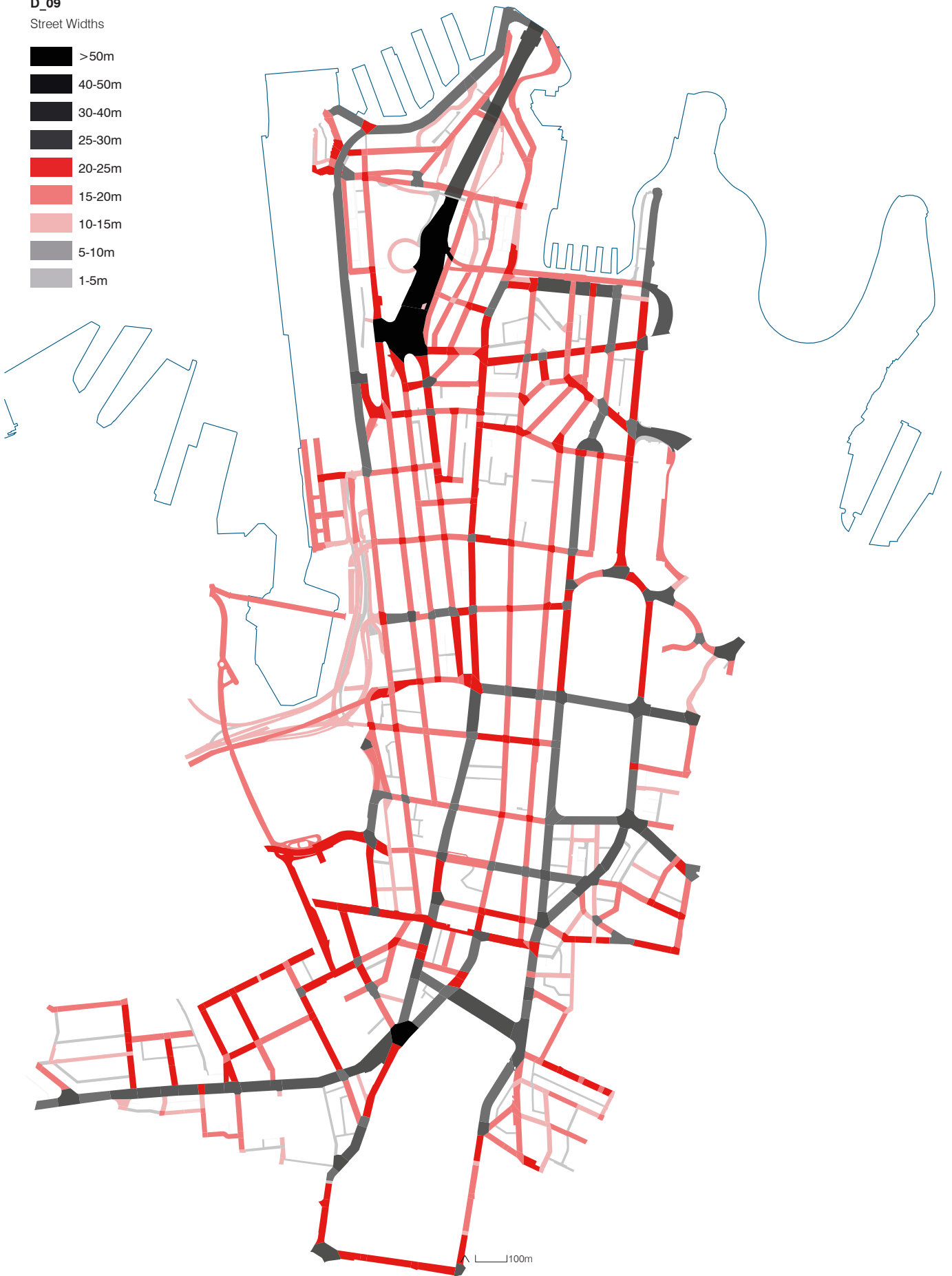
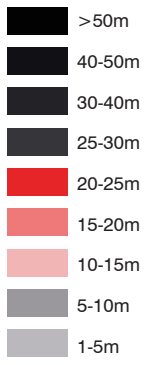

2.2.1 Wind

Windy conditions are the most significant deterrent for people in the public domain, and the most significant safety consideration.

Wind conditions are classified according to the comfort level for people – walking, standing and sitting. A low wind environment encourages sitting, where a more windy street environment is suitable only for walking. The wind environment map of the city (refer to D_13) indicates the very few areas where a calm wind environment would encourage sitting. The following considerations are noted:

- The best conditions are in the core of the city, where buildings are shielded by several blocks of tall development at the edges of the city;
- Previous height strategies have pursued a bell shaped height profile to the city to help manage wind (refer to D_12). Tall buildings are clustered together and those at the edges create the worst wind conditions in the street;
- A podium and tower typology is supported by the existing controls, to manage wind conditions in streets. As wind hits tall buildings, it is deflected downwards. Downwards wind is deflected from the street when it hits the podium (refer to D_11 in comparison to D_10);
- The small number of streets that are twisted from the main grid or interrupt the strong east-west orientation, also provide relief from windy conditions;
- Corners of east-west and north-south streets are the least comfortable wind environments for people (refer to D_13);
- Any tall edges to the city experience uncomfortable wind conditions. Macquarie Street (Botanic Gardens and east), Barangaroo (west), Rawson Place (south): and
- The wind tunnel effects in streets may be exacerbated by a consistent and tall podium height. The city's varied Street Frontage Heights help to ameliorate this.

D_10

Wind impact on tower

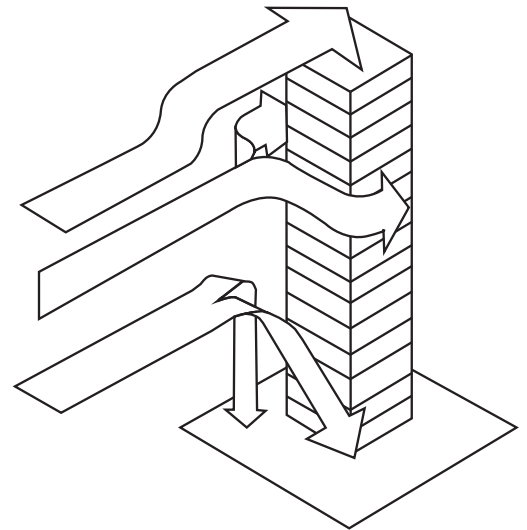

D_11

Wind impact on tower and podium form

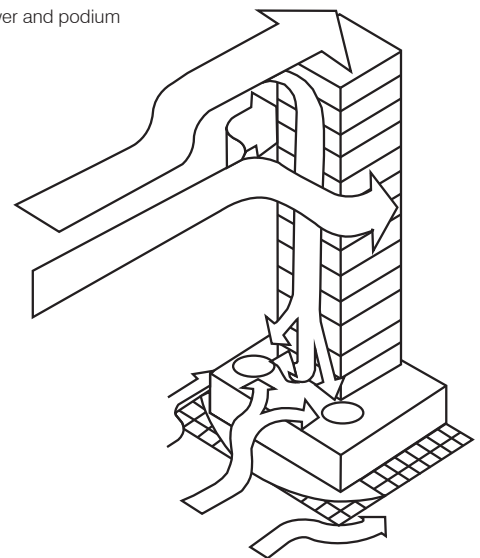

D_12

How wind moves over and through the city

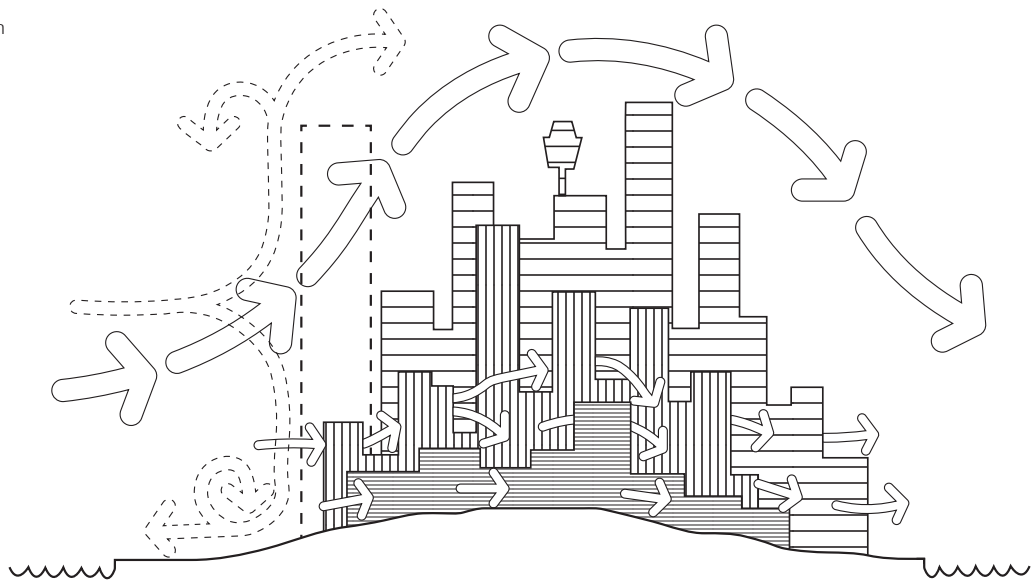

Tall Buildings and Wind

Tall buildings oriented to the street can create increased wind conditions in the public domain. Once wind is in the street, the three dimensional characteristics of streets affect the way wind moves and behaves within that space. In particular:

- Long streets can act as funnels if the wind is unable to escape and dissipate along its length. Tall, narrow spaces trap wind and cause it to funnel and circulate within the street, while broader, shorter spaces allow wind to dissipate.
- Street widths are fixed, as is the lengths of streets. The height of buildings defining the street, and the space available for wind to dissipate is affected by the Street Frontage Height and the dimension of setback to tall buildings above the street wall.

The planning controls for Central Sydney accept that windy conditions require a maximum Street Frontage Height and minimum setback arrangement to manage wind. The consequence of reducing depths of setbacks and increasing Street Frontage Heights, is that the wind conditions will become worse and adjacent landowners would then require larger setbacks on their site to compensate, otherwise the overall wind condition may become unsafe.

Wind in Laneways

Most laneways are protected from the funnelling of prevailing winds, due to their shorter lengths and location within the street network. The arrangement of laneway frontage heights and setbacks are critical where tall buildings exist or are proposed, where heights exceed 55m. Setbacks commensurate with the height of tall buildings are needed in these circumstances to deflect wind shear from the face of the tower and avoid uncomfortable conditions in the laneway.

D_13

Wind Environment
Comfort Levels

- Sitting
- Standing
- Walking

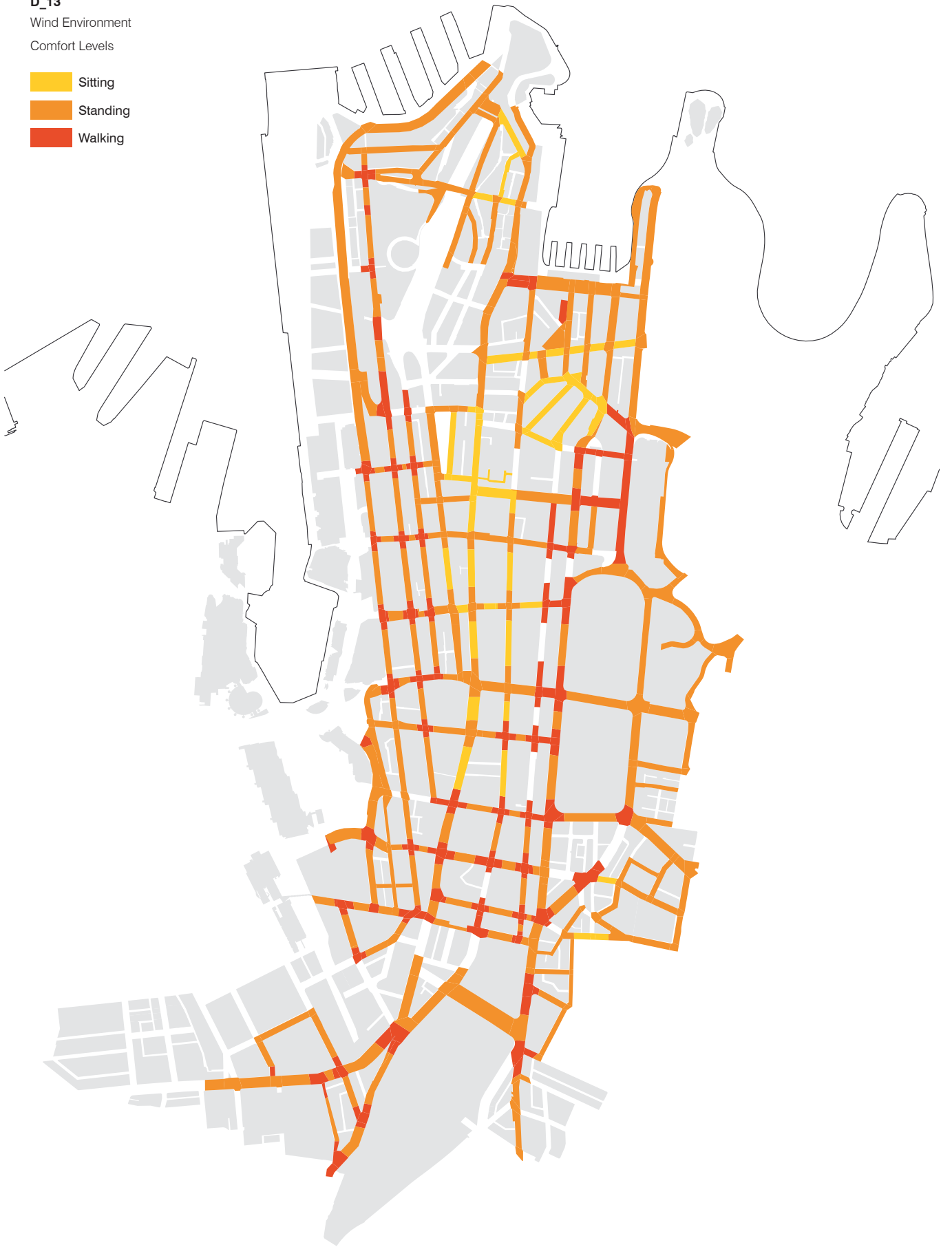

100m

2.2.2 Sunlight and daylight

The degree of sunlight and daylight in streets is a significant amenity consideration. It affects the way people use streets, their perception of attractiveness, thermal comfort and levels of light and amenity inside buildings. View of sky from within the street contributes significantly to a sense of openness in the street. These considerations are important in making a city liveable for people. Key issues to be addressed include:

- In mid-winter, most streets in Central Sydney receive less than two hours of direct sunlight per day (refer to D_15 and D_16);
- Sydney's streets are characterised by varied Street Frontage Heights. The variation of Street Frontage Heights, combined with setbacks to upper storeys and the sporadic location of heritage items, allows gaps which create more open glimpses of sky and more daylight in the street (refer to Appendix C);

- Testing shows that street intersections are an important source of light into the street network: longer streets with few intersections achieve less sky view and are generally darker. Sky view is significantly greater at intersections; and
- Open edges of Central Sydney and areas of lower development act as light wells that benefit nearby areas of taller development.

Light in Laneways

Street Frontage Height controls applying to the primary adjoining street also apply to the laneway, despite the significantly different width of the street. As a result, laneways can be relatively dark in comparison to streets.

D_14

Hours of Direct Sunlight Access to buildings in Central Sydney

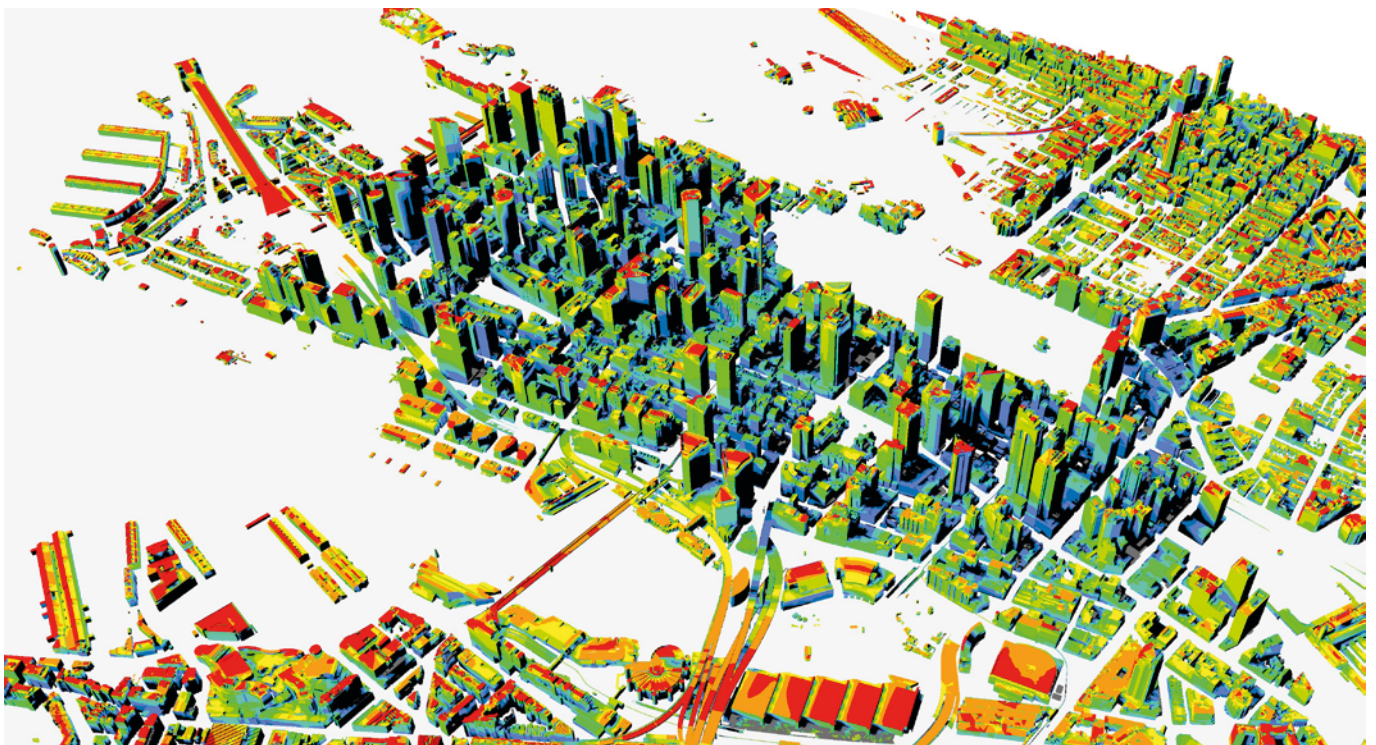

D_15

Hours of Direct Sunlight Access to Streets (mid-winter)

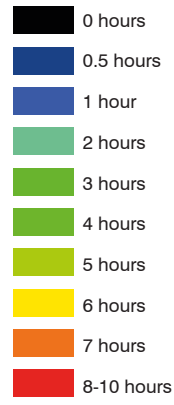
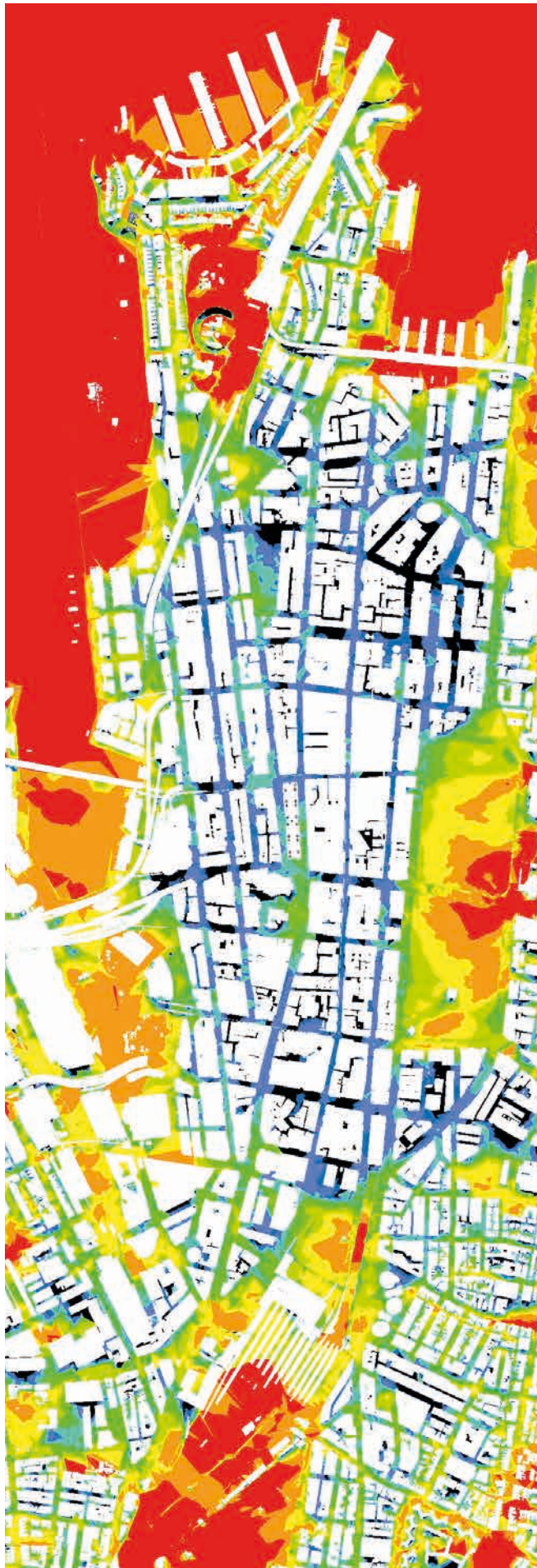

D_16

Hours of Direct Sunlight Access to Streets

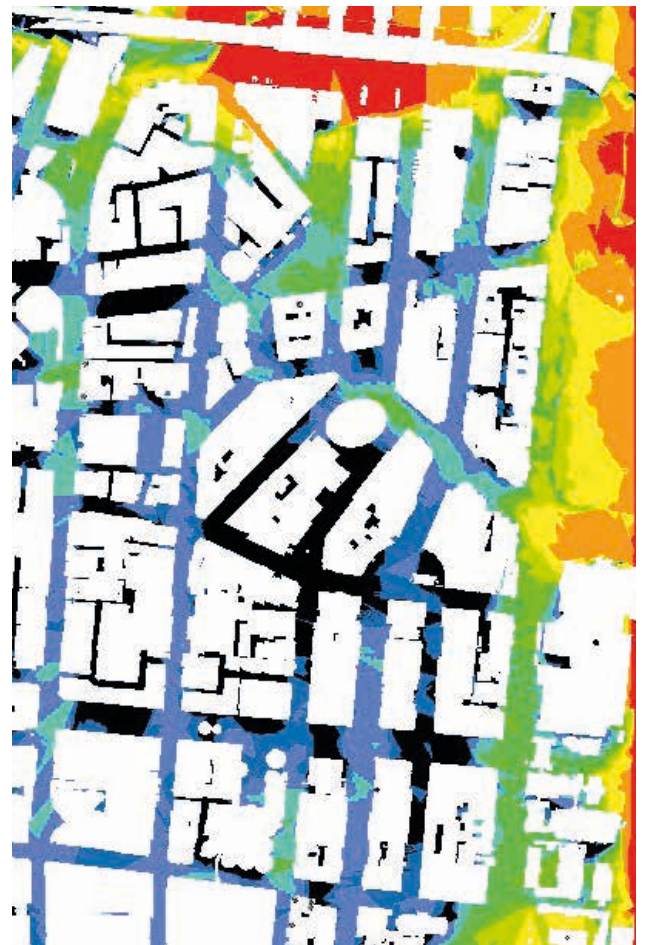

D_17
 Example Sky View
 Factor illustrations

Sky View Factor

Sky View Factor (SVF) is a measure of obstruction of the sky at any point.

SVF is a reasonable indicator of daylight levels in a street (refer to Appendix J- sub-appendix E), and can also be linked to the ability of the urban environment to release heat into the atmosphere. SVF has been used in this report as an approximation of daylight levels.

Sky View Factor is measured as a percentage where 0% is a completely obscured sky and 100% is completely unobscured (refer to example diagrams at D_17).

High SVFs are associated with brighter more pleasant streets. Conversely, low SVFs are associated with dark often unpleasant spaces.

Existing Condition

Sky View Factor was computed across the study area of Central Sydney, in GIS, using the 3D digital city model of built form and terrain. The results were mapped on a 1m x 1m grid (refer to D_18).

Mapping reveals the following:

- Central Sydney’s streets vary widely in SVF, with values between 5% to >45%;
- The SVF range for most streets in Central Sydney is 15-25%;
- The lowest SVF conditions in streets are less than <15% which is quite dark;
- Laneways typically have a SVF of <15% north of Goulburn Street, and improve to the south;
- SVF values increase for streets south of Goulburn Street;
- SVF values are typically >45% in streets at the edge of Central Sydney, particularly where they are adjacent to open space;
- Intersections have consistently better SVF than their interconnecting streets;
- Wider streets typically have higher SVFs;
- East-west streets typically have higher SVFs; and
- Streets adjacent to open space have the highest SVF.

The existing SVF values vary along the width or length of streets. This confirms that the sky view is affected by the proximity of built elements to the location where the measurement is calculated and the overall composition of built elements.

The mapping indicates that the width, alignment and orientation of streets also contributes to SVF values.

SVFs are best understood with reference to experience. Conditions can best be understood by examples which are shown below each SVF map.

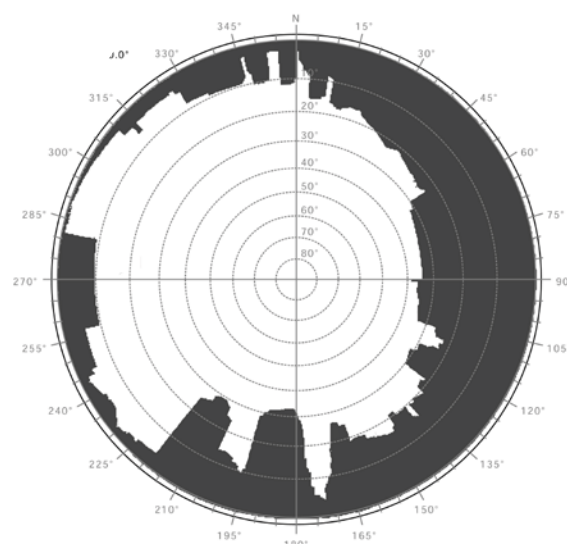
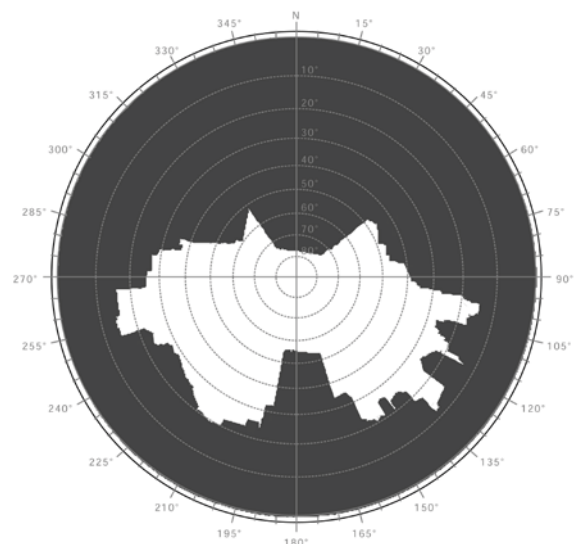
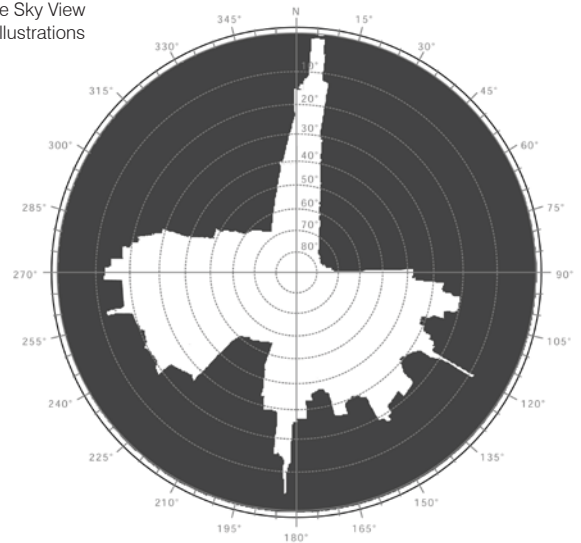

D_18

Existing Sky View Factor (%)

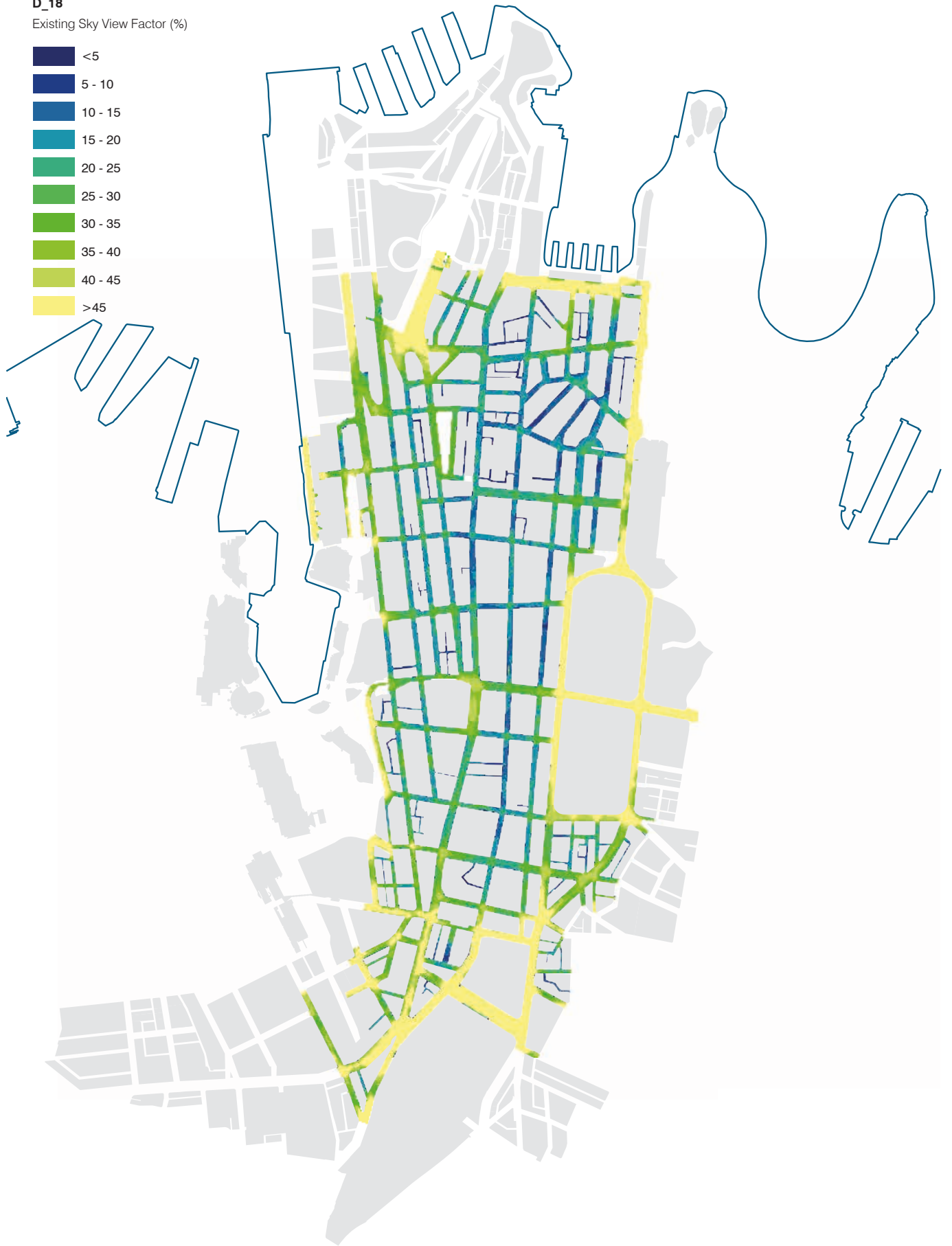
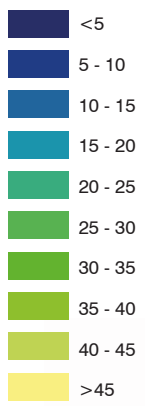

100m

Streets with low SVF (<15%)

A SVF of less than 15% represents the darkest conditions in Central Sydney.

A very small proportion of public places in Central Sydney have a SVF of less than 10%. This condition is limited primarily to laneways, small streets, and some streets in the northern core (see below).

SVF in laneways is particularly low, because:

- The space between buildings is narrow;
- The ratio of height to street width is high; and
- The laneways are short and long views to sky are obscured by buildings on terminating streets.

Short streets in the northern core <15% are dark because:

- The topographic bowl and twisted street grid contribute to low SVF;
- Rising topography elevates the horizon on long views, and the height of tall buildings on short views;
- Long views are not available because the street is terminated by another, perpendicular, street. Examples include:
 - Parts of North-South Streets east of George Street
 - Some parts of Castlereagh, Pitt and Philip Streets (north of Goulburn)
- These streets are affected some of Central Sydney's tallest buildings; and
- Streets are narrow and long and are sometimes slightly bent blocking long views.

D_19

Streets with low Sky View Factor

<5%



Example street with low Sky View Factor <5%

Wynyard Lane



D_20

Streets with low Sky View Factor
5%-10%



Example street with low Sky View Factor 5%-10%
Dalley Street



D_21

Streets with low Sky View Factor
10%-15%



Example street with low Sky View Factor 10%-15%
Castlereigh Street north of Park St



D_22

Streets with typical Sky View Factor

15%-20%

Streets with a typical SVF (15-25%)

This category represents the majority of street environments in Central Sydney.

In relation to the North-South Streets on the Western Edge:

- These streets benefit from long views in either direction because they are straight;
- The streets run parallel to the contours, so long views are not so affected by topography; and
- The built form is generally lower in this part of the city than to the east of George Street.



Example street with typical Sky View Factor 15%-20%

York Street north of Market St



D_23

Streets with typical Sky View Factor

20%-25%



Example street with typical Sky View Factor 20%-25%

Martin Place



D_24

Streets with higher Sky View Factor

25%-30%



Streets with a higher SVF (25-35%)

Higher SVF conditions exist particularly:

- At intersections;
- On wider east west streets such as Bridge Street and Martin Place;
- On Sussex Street, where tall development is limited to the eastern side of the street; and
- Around Wynyard Park.

East-west oriented streets tend to have higher SVFs than others in Central Sydney because:

- They are shorter, so the long view does not narrow so much over a long distance;
- They are open to the sky to the east and west as topography slopes off or open spaces / harbour are approached;
- These streets are often wider than north-south streets; and
- They have more regular intersections along their length, which lifts the overall SVF.

Example street with higher Sky View Factor 25%-30%

Elizabeth Street south of Liverpool St



D_25

Streets with higher Sky View Factor

30%-35%



Example street with higher Sky View Factor 30%-35%

York Street at Wynyard Park



D_26

Streets with highest Sky View Factor

35%-40%



Streets with highest SVF (>35%)

Streets with highest SVFs are those that are:

- located at the edge of Central Sydney;
- are south of Goulburn Street, where building heights are lower;
- are west of Sussex Street, where building heights are lower; and
- are at Town Hall, where a cluster of heritage buildings within open space significantly open views to the sky.

Determining factors contributing to SVF

The analysis of existing SVF in Central Sydney indicates that SVF values increase and decrease within the 5-40% range in response to the following factors:

- Height of buildings;
- Width of street;
- Length of the street;
- Alignment of the street;
- Topography;
- Gaps between towers;
- Street Frontage Heights and setbacks; and
- Proximity to an open space, an intersection or the edge of the Central Sydney boundary.

Width, alignment and orientation of streets

In general, the following is observed from the mapping:

- East west streets generally have higher SVFs, particularly on the western side of George Street;
- North south streets vary greatly but generally have higher SVFs on the western edge (impact of topography and built form);
- Twisted streets or short streets have substantially lower SVFs (lack of long view);
- The south end of Central Sydney generally has the highest SVFs; and
- Wynyard Park and Town Hall are pockets of lower SVF that provide relief.

Example street with highest Sky View Factor 35%-40%

Wentworth Avenue south of Liverpool St



D_27

Streets with highest Sky View Factor

40%-45%



Example street with highest Sky View Factor 40%-45%
Macquarie Street south of Hunter St



D_28

Streets with highest Sky View Factor

>45%



Example street with highest Sky View Factor >45%
Macquarie Street north of Bent St



2.2.3 Scale

The scale of buildings affects the human perception of the city and the role of people within it. A place of human scale allows people to relate to, interact with, and appreciate their context.

In regards to scale, both the Street Frontage Height (SFH) (building frontage to street) and the width of the street must be considered together. What seems to be a tall building in one street, may not seem tall in a wider street. This study reviews the patterns of Street Frontage Heights in regards to character and amenity as well as the impact of Street Frontage Heights, specifically on overall human scale of the street. This is done by comparing Street Frontage Height directly with street width to identify a ratio. Generally in urban literature, a ratio of 1-1.5:1 is considered to be a comfortable scale. This is where the Street Frontage Height is between 1 and 1.5 times the width of the street. Additional considerations include:

- Existing street widths vary across Central Sydney, few are 20m or more;
- On comparison of the Street Frontage Height to width ratio map (refer to D_30), and the Sky View Factor map (refer to D_18), there is a direct relationship between high ratio value, and low Sky View Factor. Sky View Factor is lower where streets are narrow and street frontage is higher;
- Street Frontage Height to street width ratio is varied; and
- The distances over which current SFHs are perceived is very long (refer to D_29, D_31 and D_32).

Scale of Laneways:

The narrow condition of lanes creates very different scale and character considerations to that of existing streets. Principles in regard to Street Frontage Height and laneway width ratios cannot be directly translated to laneways. A taller built edge in proportion to laneway width is characteristic of many laneways in Central Sydney, particularly in the old warehousing area of the western edge precinct.

Scale and daylight are a significant issue in relation to laneways as Central Sydney intensifies and laneways increasingly become places for people as much as, or more than, servicing for buildings. As such, the built form edge to laneways and setback of upper storeys should be managed to promote daylight access and a comfortable human scale appropriate to the laneway condition. Generally, a lower built form edge than what is permissible in streets is preferable, in proportion with the width of the laneway.

There are three particular built form considerations where laneways exist:

1. Small site where heights will not be permitted to exceed 55m. In these cases there is pressure to minimise setbacks to maximise yield;
2. Sites where taller buildings are permitted; and
3. Sites where large floorplates are achievable.

It is noted that:

- Current controls do not represent a place-making approach to laneways;
- Current controls may not achieve adequate separations between buildings across laneways; and
- Overall city SFH controls should be reduced.

D_29

Angles and distances of human perception of varying Street Frontage Heights - 16m wide street

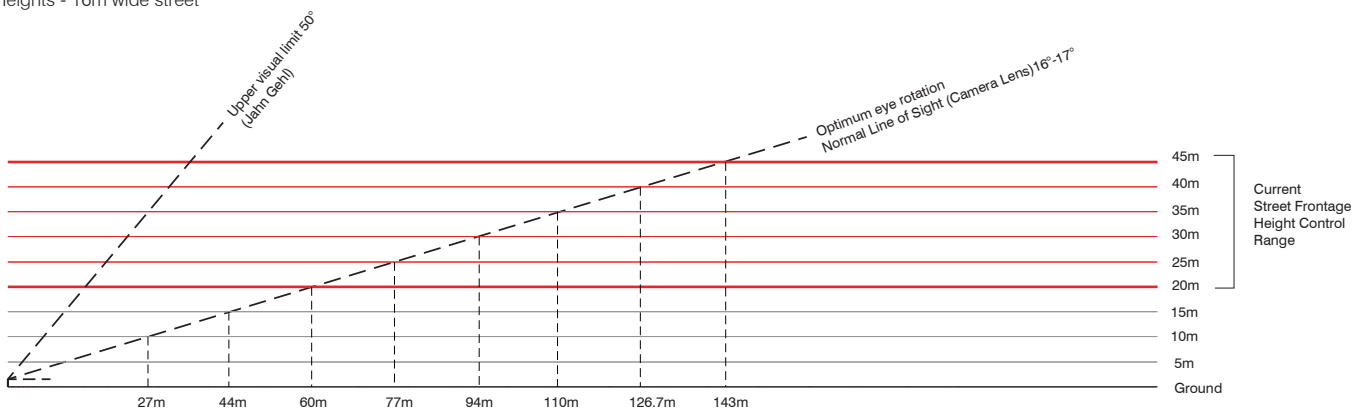

D_30

Street Frontage Height to Width Ratio

- 0 - 0.25
- 0.25 - 0.5
- 0.5 - 0.75
- 0.75 - 1.00
- 1.00 - 1.25
- 1.25 - 1.50
- 1.50 - 1.75
- 1.75 - 2.00
- 2.00 - 2.25
- 2.25 - 2.50
- 2.50 - 2.75
- 2.75 - 3.00
- >3.00

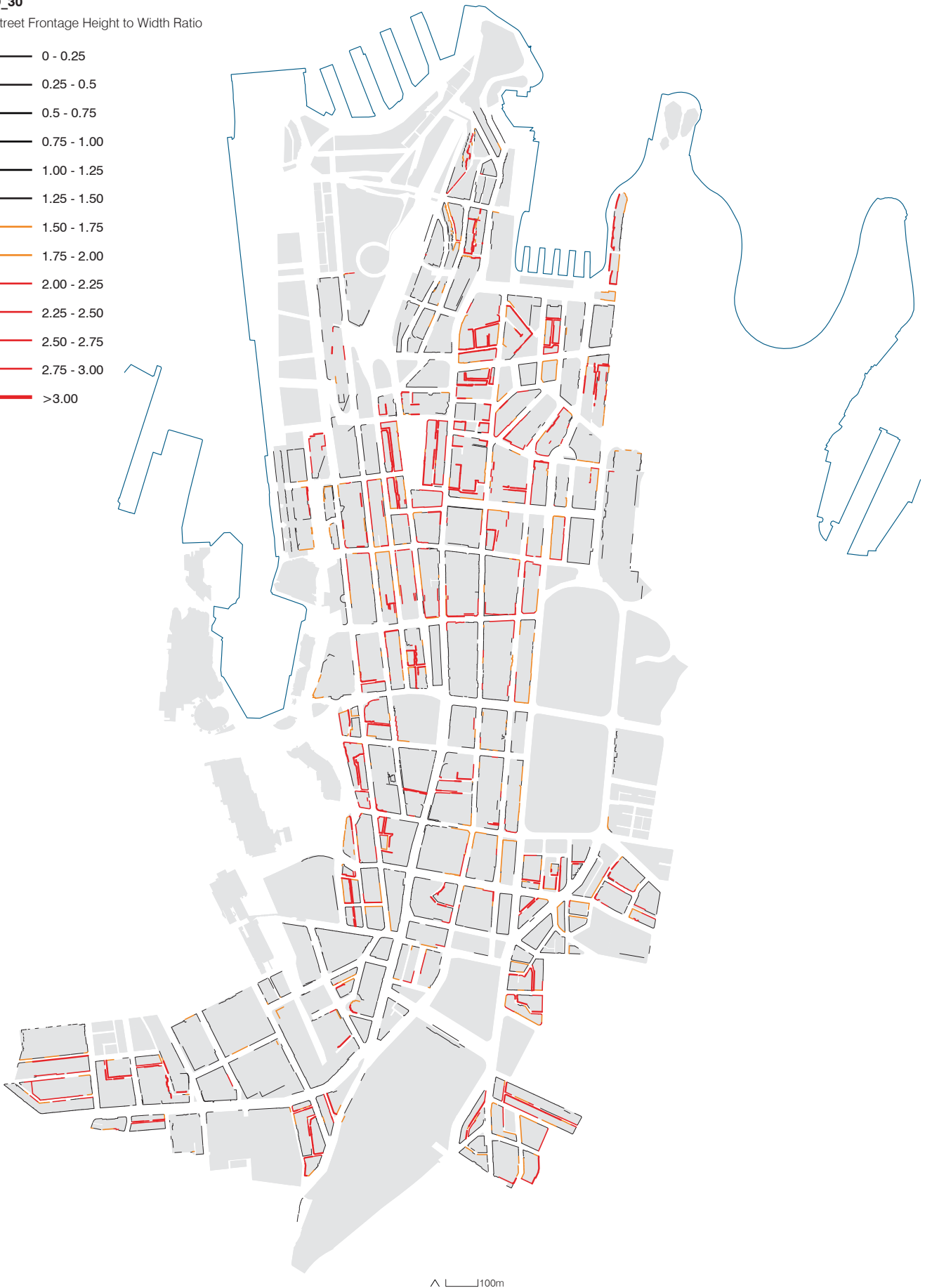

^ 100m

D_31

Human Perception of Street Frontage
Height from the centreline of the street

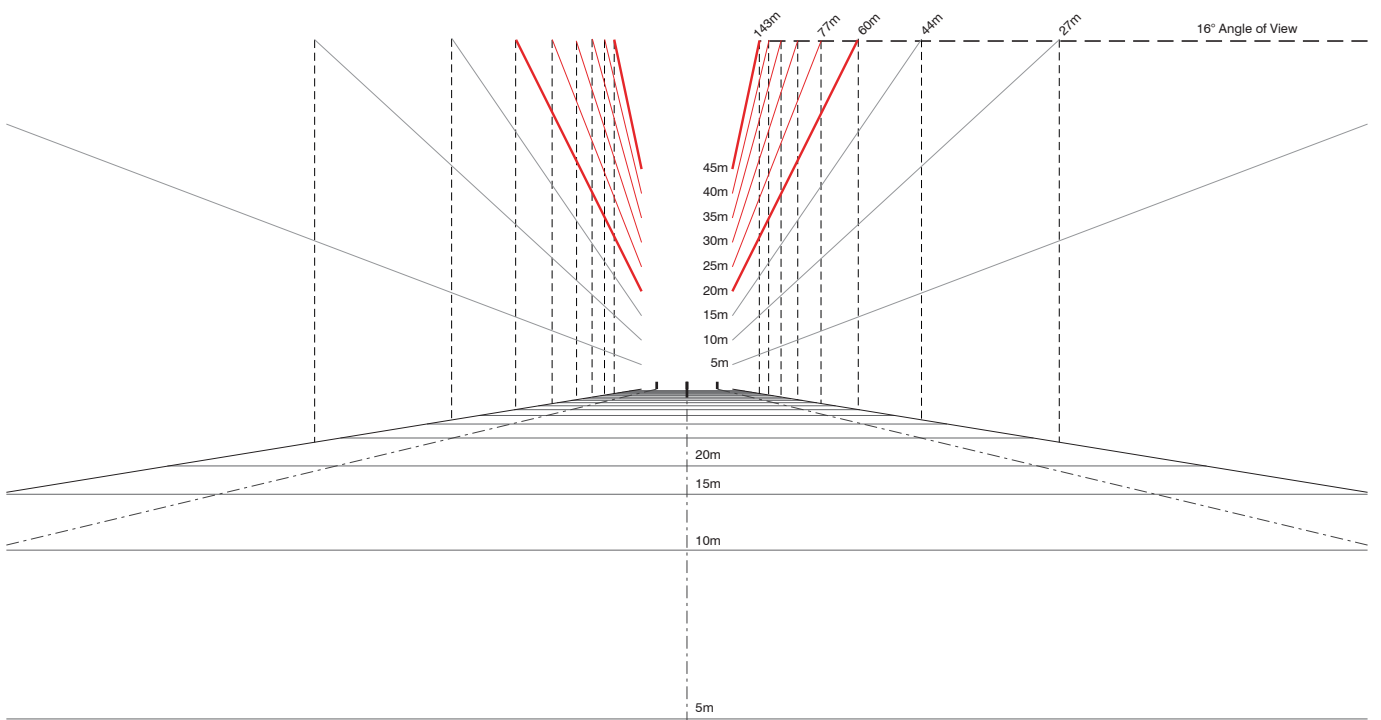

D_32

Human Perception of Street Frontage
Height from the footpath

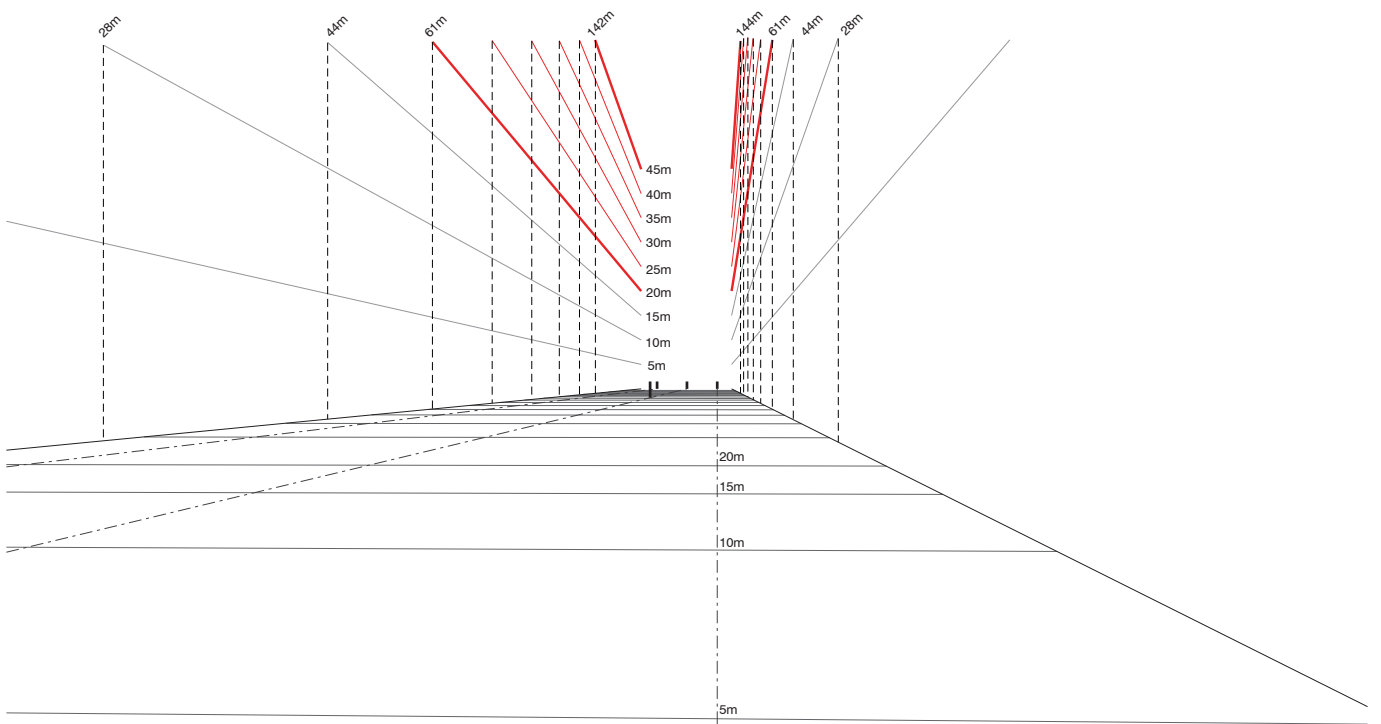

2.3

Mapping Street Frontage Height and Setback Conditions

Street Frontage Height and Setbacks

The existing control is based on the predominant condition in Central Sydney, where approximately 80% of Street Frontage Heights were within a range of 20-45m (1995 DCP Part 2).

Most Street Frontage Heights in Central Sydney are below 45m (refer to D_33 and D_34) with a small number up to 60m (refer to D_35). There is a greater level of consistency of SFH in some of the Special character Areas, for example the York Street, Clarence Street and Kent Street areas - generally around 35-45m (refer to D_34) and the Haymarket/Chinatown area - generally below 20m (refer to D_33).

D_33

Existing Condition

Street Frontage Height

Special character Area

<20m



100m

D_34

Existing Condition

Street Frontage Height

Special character Area

20 - 45m



D_35

Existing Condition

Street Frontage Height

Special character Areas

45-50m

50-60m

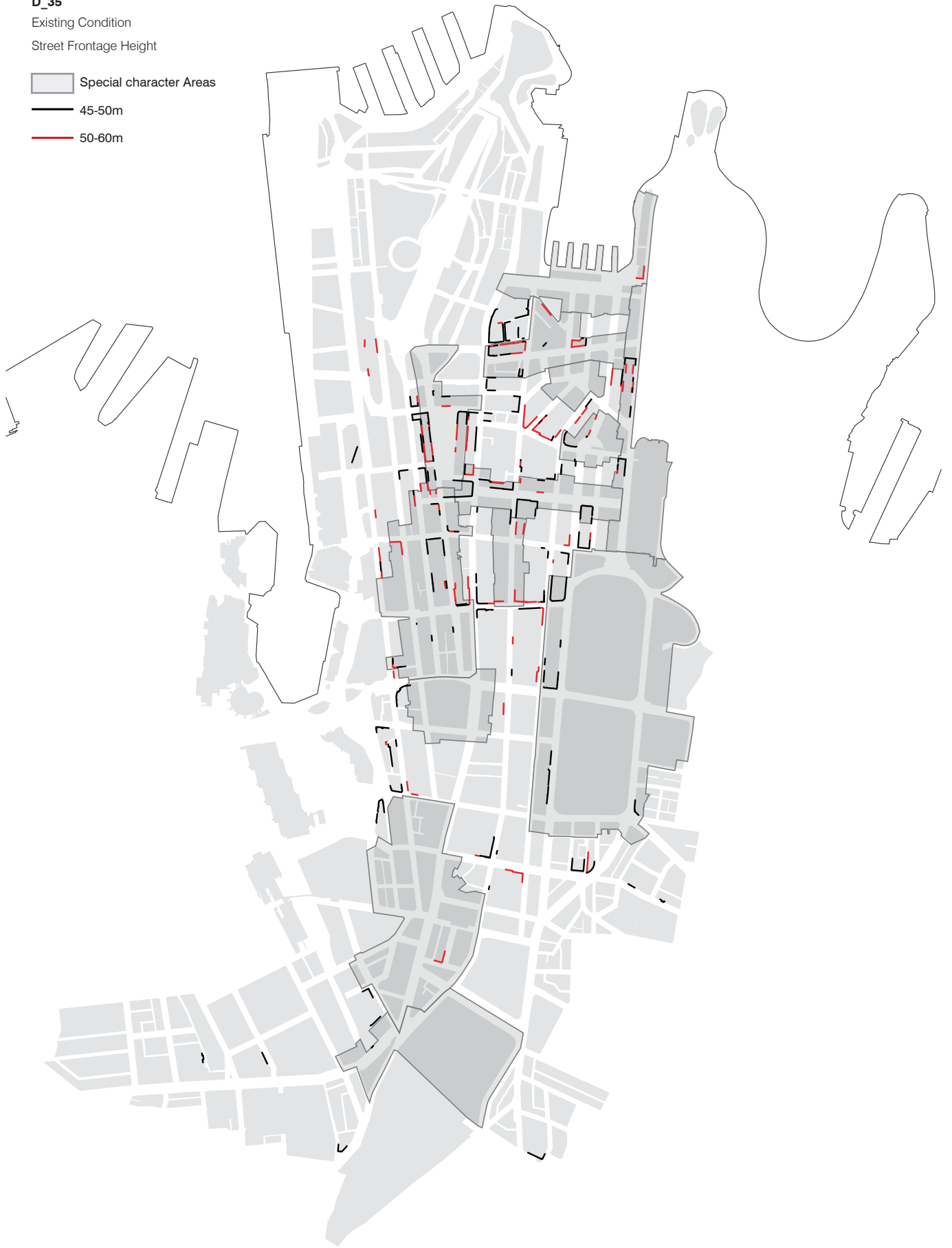

100m

3

Analysis and issues

D_36

New York City SFH and Setback Controls (shown grey)
Compared to City of Sydney SFH and Setback controls

3.1

Street Frontage Height and Setbacks Controls

To further understand the complex considerations of how the controls are performing in achieving their objectives, the existing condition has been mapped, analysed and compared with the existing controls (refer to D_38).

Mapping of the existing condition and compliance with the current setback controls indicates that there is a high degree of non-compliance with the controls.

The degree of non-compliance that is not associated with a heritage item, or developed prior to the controls, indicates that the control is often varied. Given it is a DCP control, it is most likely that the DCP control has been varied as opposed to the LEP control.

Some street blocks in Central Sydney are simply too narrow, and some block sizes too small, to accommodate all the required front, side and rear setbacks and still enable a viable tower floorplate. This places significant pressure on all setbacks.

The implication of continued variation to Street Frontage Height and setback controls is a worsening of amenity in the street. The setback controls should be amended to allow variation and articulation of the built form to achieve architectural variation, while still meeting the overall objectives and intent of the setback controls.

An international comparison of street frontage setback requirements indicates that Central Sydney's controls are not overly onerous (for example refer to D_36 and D_37). In fact, they are generally less onerous, which is likely due to the highly constrained nature of many street blocks.

New York has a successful system of recess and compensation within the setback zone that allows for a unique architectural response while maintaining an overall minimum setback deemed necessary to meet minimum daylight requirements in the street.

The planning framework for Central Sydney should be amended to incorporate a system for variation of the setback that also protects the amenity of the city for people.

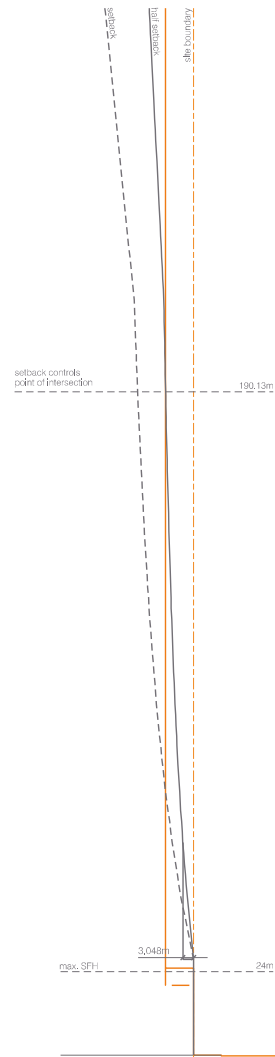



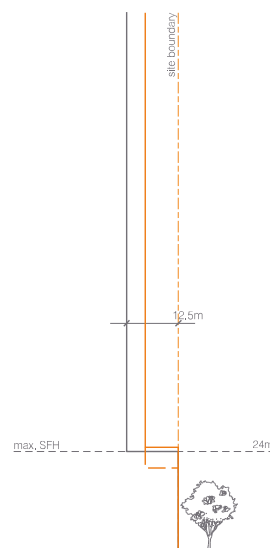

D_37

Toronto SFH and Setback Controls
Compared to City of Sydney SFH and Setback controls



D_38

Existing SFH and Setback Non-Compliance and Heritage Items

-  Heritage Item
-  Special character Area
-  Breakage to Street Frontage Height Controls
-  Street Frontage Height and Setback Control Extent



3.2

Setbacks and Separations

Separation requirements for taller buildings on adjacent sites are mainly managed by side and rear setbacks.

As previously discussed, adequate separations are essential for balancing amenity with capacity in Central Sydney. Separations are essential for wind and air quality management, allowing light and air into buildings and into the street and to assist with managing privacy and outlook in the dense urban environment.

The solar insolation and skyview factor mapping of the existing condition (refer to D_18 to D_28) clearly demonstrated that the areas with fewer towers, or greater tower separation, had better levels of amenity in the street.

There are some intrinsic difficulties with the current controls in protecting and achieving adequate separations, these include:

- There are no specific separation controls applying to buildings on separate sites for blank walls of commercial buildings. SEPP65 separation requirements are enforced for residential buildings. Adequate separation can only be guaranteed if provided on within a development site;
- Limited site sizes can create pressure on setbacks (refer to D_39 to D_45), where development extends into or over the setback zone to maximise floorplates to a viable size on small sites. This has sometimes been permitted where there are certain contextual circumstances where amenity can be borrowed from an adjacent site, such as:
 - there is an heritage item adjacent, where development is low and unlikely to change;
 - floorspace on the adjacent property has been transferred elsewhere and there is an easement in place in stratum to protect airspace above the development;
 - development on an adjacent site is setback further than required, enabling the new development to reduce their setbacks while still achieving adequate separation; and
 - The new development involves the refurbishment of an existing building, that does not comply with setbacks.
- With the exception of the first, all of the scenarios listed above create constraints to the efficient use of land for growth of the city by inhibiting the development opportunities for adjacent sites; and
- The impact on adjacent sites is greatest where the new development is residential, as greater separations are required for this use. This also places greater constraints on the adjacent sites.

The planning framework should be revised to incorporate stronger or clearer controls to manage separations, particularly as buildings get taller.

D_39

Setbacks from side and rear boundaries

Commercial Buildings

One building with windows

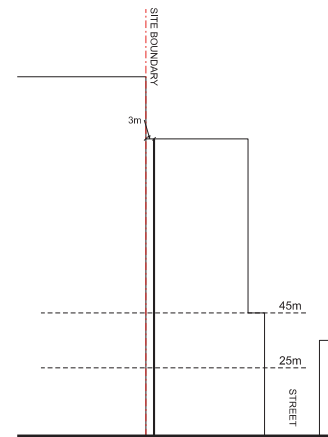

D_40

Setbacks from side and rear boundaries

Commercial buildings

Party wall development

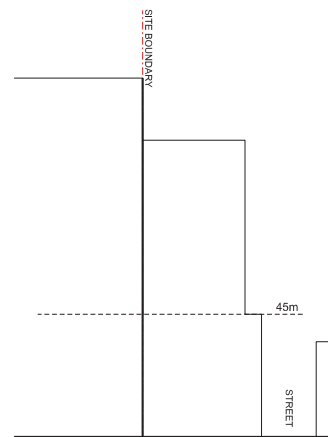

D_41

Setbacks from side and rear boundaries

Commercial Buildings

Both Buildings with windows

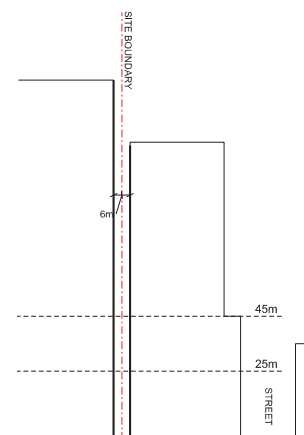

D_42

Setbacks from side and rear boundaries
Residential Buildings
Both buildings with windows

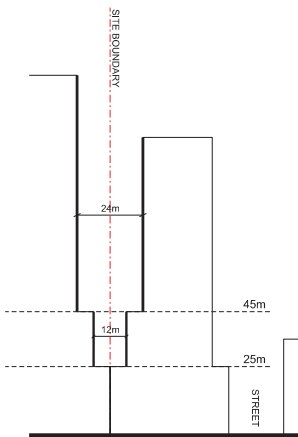

D_44

Setbacks from side and rear boundaries
Residential Buildings
One building with windows

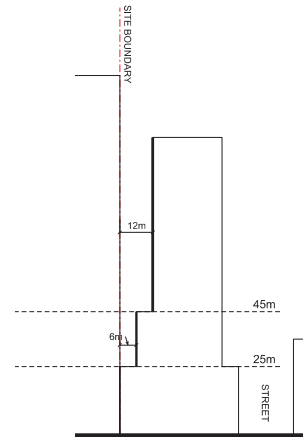

D_43

Setbacks from side and rear boundaries
Residential and Commercial buildings
Both buildings with windows

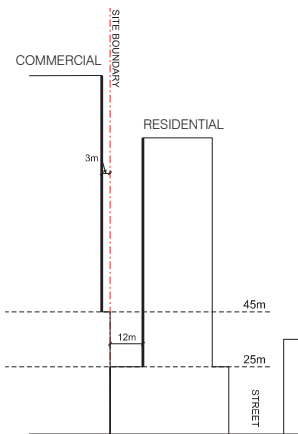

D_45

Setbacks from side and rear boundaries
Residential and Commercial buildings
Residential building with windows

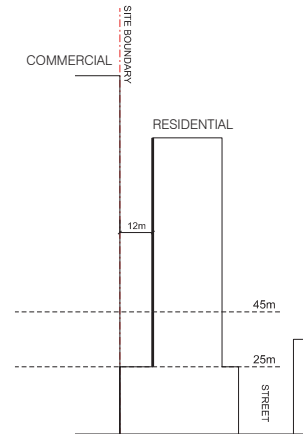

3.3

Capacity for Growth

General Built Form Controls affect the physical capacity of Central Sydney to accommodate floorspace.

Variations to side, rear and street frontage setback controls have been tested for their impact on capacity for growth, as described in the Built Form Capacity Appendix B.

A 'base case' of 8m setbacks has been compared with variations of each setback type.

The impact of various setback configurations have been tested, and are tabulated at D_46.

Opportunities for the growth of Central Sydney are limited, with significant constraints to outward growth. In some parts of Central Sydney, additional height could be achieved to release capacity necessary for the development of Central Sydney in line with Strategic Directions.

Additional capacity would be released by removing or reducing setback controls as demonstrated by the table.

The bell curve shape of the city currently works to manage wind impacts at the edges, allow light into the centre of the city and promote view sharing. A change to the shape of the city would potentially change these conditions.

3.4

Balancing Amenity and Capacity

This analysis investigates the potential impacts on streets and the role of Street Frontage Height and setback controls in mitigating these impacts.

The likely impact of increased heights will be mostly borne by streets. Impacts on amenity and character will include:

- Windier conditions in streets at the base of buildings;
- More wind and winds of greater speeds;
- More wind displaced from tall buildings at the edges of the city and funnelled into streets;
- Increased heights which would further obscure direct sunlight into streets;
- Sky view in streets which would be obscured by taller buildings, reducing daylight and making streets feel darker and more enclosed;
- The loss of light wells into the city that are currently created where pockets of lower development interrupt areas of tall development;
- Reduced human scale;
- Sharper transition from areas of tall development to lower, heritage, areas on the edges;
- Worsening of the urban heat island effect.

Controls should be developed that allow variation to setbacks to maximise efficient use of land where amenity in the public domain is not reduced relative to a complying envelope.

3.5

Wind

The following considerations are made:

- Wind is the most significant deterrent for people in the public domain, and the most significant safety consideration.
- Refer to Appendices I and J.
- Edge conditions likely to become more windy, particularly along south-western edge
- Increased measures to reduce wind impacts at the base of tall buildings will be required, such as larger setbacks above the street wall, awnings etc)
- A coordinated approach to wind management in streets will be required to diminish wind tunnelling effects – particularly entails creation of a varied and generally lower Street Frontage Height, with compliant setbacks

D_46

Capacity impacts of setback controls

North/South Street	East/West Street	Lane	Common Boundary	Capacity Percentage
8	8	8	8	100%
4	8	8	8	122%
8	4	8	8	108%
8	8	2	8	109%
8	8	8	4	121%
4	4	2	8	142%
4	4	4	8	138%
6	8	4	8	117%
6	6	4	8	122%
6	6	2	8	125%
6	6	2	6	136%
4	4	2	4	165%

3.6

Daylight

The potential impact of the preferred growth strategy on light in streets was analysed (using SVF as a proxy). The analysis was done using a 3D model of possible future development in Central Sydney. Sky View Factor values on the ground plane were measured for areas likely to experience the most significant changes (Pitt and Kent Streets) and compared with the existing condition.

Three variations of the model were analysed, measuring varying approaches to Street Frontage Height and Setback. The heights remained constant in line with the preferred growth strategy. In this way, it is possible to understand the impact of possible development control scenarios on light levels in streets.

The three scenarios that have been modelled are generally representative of the setback and Street Frontage Height issues under consideration (refer to D_47).

All the options have building heights defined by the growth strategy. The variables are the street setback and SFH.

D_47

SVF options testing

	Street setback	SFH	Heights
Existing condition	Existing setbacks (generally 4-8m)	Existing SFHs (generally up to 45m)	Existing maximum building heights (generally up to 235m)
Option 1	8m	25m	Growth strategy
Option 2	8m	45m	Growth strategy
Option 3	0m	N/A	Growth strategy

Notes on the SVF options testing:

Option 2 most closely reflects a continuation of current setback and SFH controls.

Options for setback controls in the range of 0-8m can be determined by interpolating between the results for Option 3 and Options 1&2

The results of the SVF options tests are shown in D_49 as rank ordered values. Average and median values are shown in table D_48. Example maps showing the extent of SVFs <15% for each option tested are shown at D_50 to D_53.

The data shows that all the options have considerably lower SVFs compared to the existing condition. This is a result of the increased number and height of towers in the tested options. A higher street wall height creates an additional 25% decrease in average SVF. Reduced setbacks creates an additional 66-88% decrease in SVF (depending on use of median or average values compared to Option 1).

The median SVF of the existing conditions in these areas is quite low at around 20% which is similar to the existing conditions in Pitt Street and York Street between Market and King Streets. The growth strategy will reduce the median SVF to between 12.8 to 15.6% depending on the final setback and SFH controls adopted. These SVFs are similar to those found in Castlereagh Street between Market and Park Streets and on Bligh Street.

D_48

SVF options testing - average and median outcomes

	Average SVF (% change)	SFH (% change)
Existing condition	21.29 (100%)	19.69 (100%)
Option 1	17.85 (-16%)	15.59 (-21%)
Option 2	16.95 (-20%)	14.74 (-25%)
Option 3	14.90 (-30%)	12.83 (-35%)

D_49

SVF options testing - rank ordered graph of SVF data

- Existing condition
- Option 1 - 8m setbacks (25m podium)
- Option 2 - 8m setbacks (45m podium)
- Option 3 - 0m setbacks (no podium)

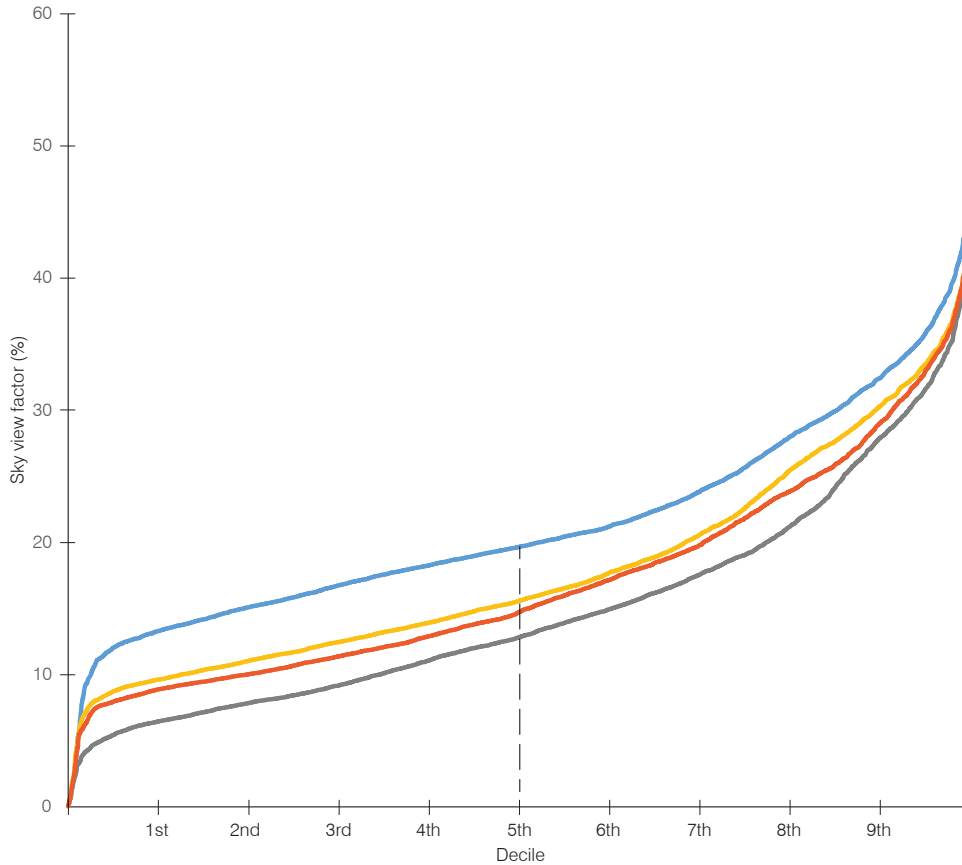

Conclusions

The impact of Street Frontage Height is significant, but relatively localised. Mapping shows that the impact of a 0m setback has a far reaching effect on the street.

The variation of setbacks above the Street Frontage Height has a much more significant effect on SVF than variation in SFH.

The variation of setbacks (0 vs 8m) has a much greater effect on SVF than the variation of Street Frontage Height within the range of (25 vs 45m), i.e. SVF (and daylight) is substantially more sensitive to variation of the setback control.

The SVF condition at intersections (corners) is more critical than other points in the street because corners provide lightwells into the city that lend light and outlook to a greater proportion of the city.

D_50

SVF <15%

Existing condition



D_51

SVF <15%

8m setbacks (25m podium)



D_52

SVF <15%

8m setbacks (45m podium)



D_53

SVF <15%

0m setbacks (no podium)



D_54

Low angle views of sky
Perspectives West along Liverpool Street

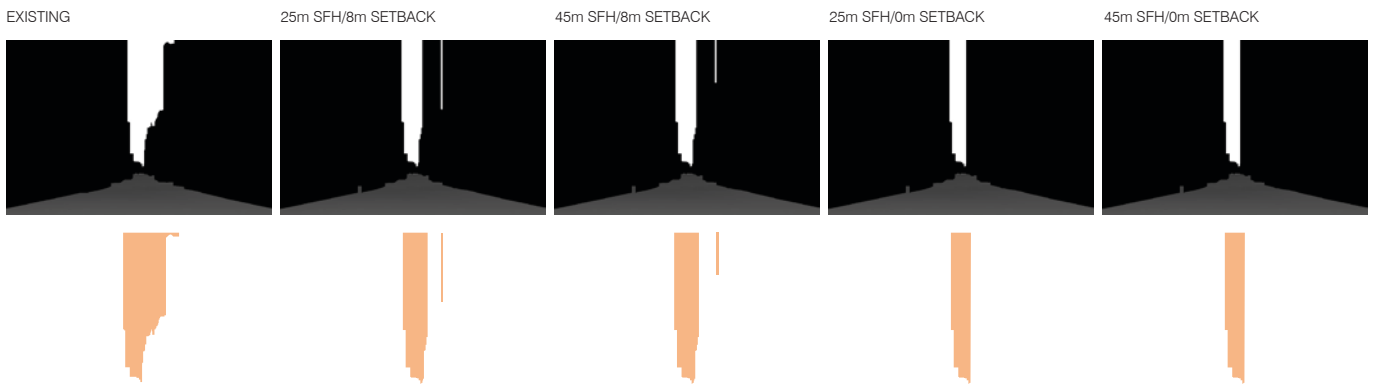

D_55

Low angle views of sky
Perspectives North along Pitt Street

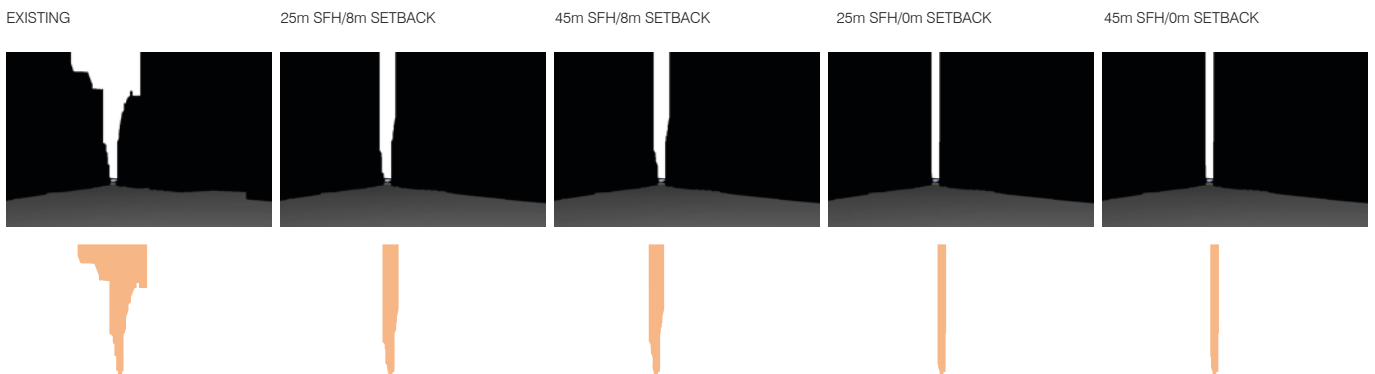

4

Conclusions and recommendations

4.1

Conclusions: Discussion

General

Based on the impacts of podium height and setback on wind, light, scale and character of the streets, the following considerations are made:

- This study indicates that 45m is too high for a Street Frontage Height in most streets. If amenity objectives for streets are to be achieved the SFH must be reduced;
- 35m as a maximum SFH is a more appropriate maximum, for the purposes of amenity and character;
- For major new tall tower development, podiums should create a street wall edge of maximum 25m; and
- Applying setback controls indicate that there are some street blocks that are too narrow to achieve large scale tower development, whilst achieving minimum separations and protection from severe impacts on amenity in the street.

Street wall buildings and tower podiums

Street wall buildings and tower podiums should be set at an appropriate height with respect to:

- the overall form of the street wall, considering nearby heritage items; and
- the width of the street, considering human scale; and
- the management of amenity within the street, particularly managing wind, daylight and human scale.

Street Frontage Height

Street Frontage Height must reflect existing patterns, variation, heritage and character. The following considerations are noted:

- Sydney's streets are characterised by a fine grain street frontage with varied Street Frontage Heights. The variation of Street Frontage Height is reflective of the different approaches to development that have shaped the city;
- In many ways this variation in heights is a very positive attribute, creating variety and interest in the built form across the city, emphasising precincts or areas of special character;
- Areas of special character occur where similar built form, and often consistent Street Frontage Height, are clustered together in one or several adjacent streets. (see Special character Areas section);
- Where lower and higher Street Frontage Heights are mixed, the lower heights compensate for the higher heights. This improves light, air, skyview and scale impacts in that location. In some cases where heritage items have a tall Street Frontage Height that must be retained, lower Street Frontage Heights in the immediate locality improve daylight conditions in the street as well as maintaining prominence of the heritage item in the streetscape;
- Street Frontage Heights vary predominantly between 20 and 45m but in some cases it is lower or higher;
- There are a number of buildings with higher SFH than 45m, or lower than 20m, that are heritage items or part of a Special character Area;
- There are some buildings, however, that are higher or lower than this range because they are an inappropriate built form typology. Most often these are towers that have been built without a podium element at the base; and
- In some cases the Street Frontage Height does not exist because previous development has broken the pattern by concentrating floorspace in a tower and leaving areas of open space around it.

Determining an appropriate Street Frontage Height

The ideal Street Frontage Height varies according to the width and orientation of the street.

To achieve good human scale in the street, a Street Frontage Height to street width ratio of 1-1.5:1 is preferred.

For daylight into the street, the orientation and width of the street, together with the amount of Sky View available are important considerations.

- The City's street network is a loose grid of predominantly long north-south streets intersected by shorter (and wider) east-west streets.
 - The north side of east-west streets are permanently in shade, but the east-west streets are shorter and wider, with wider views in the distance;
 - East-west streets are frequently intersected and the intersections create injections of daylight; and
 - North-south streets benefit from northerly sun throughout the middle of the day, but are dark in the mornings and afternoons. These streets are long and narrow with long blocks and fewer instances of openness for daylight occurring along their length.

Setbacks and Separation

It is recommended that:

- Tower forms are setback from the site boundaries all around, expressing the podium, and creating space around them that lets light and air into the street.
- Where the tower is setback from boundaries, it creates space around itself providing outlook, and allowing daylight to reach internal spaces.
- More daylight is required for some building uses, such as residential, and in these cases, larger tower setbacks are required to meet those needs.
- Generally, streets in Sydney are narrow and do not provide enough separation between buildings on their own. Additional setbacks above the Street Frontage Height are required to achieve adequate separation.

4.2

Recommendations

Street Frontage Heights

Lower Street Frontage Heights in Central Sydney are desirable. Generally, a reduction from 45m to between 25 and 35m is desirable to increase the perception and reading of the street wall and to increase daylight levels in streets. For very tall towers, improving daylight levels is more important so it is desirable that the SFH is at the lower range of 20-25m.

Street setbacks

Street setbacks should be maintained at an average of 8m, understanding the importance of the environmental benefits of setbacks i.e. management of downdrafts and increasing daylight in streets. Some variation should be permitted to setbacks where environmental conditions are not worsened. Such a test could be used in relation to side and rear setbacks (provided for amenity of the public domain).

Side and rear setbacks

The multiple purposes of side and rear setbacks should be clarified.

The first purpose is to provide outlook (and visual privacy) for occupants of the building. Setbacks for this purpose only relate to windows and balconies and will be dependent on the orientation and relationship to surrounding public places.

The second purpose is to provide amenity for the public domain. Amenity setbacks provide daylight to streets, they also allow movement of air to flush street canyons of heat and pollution.

The third purpose is to allow towers to be understood “in the round” as architectural objects and to create a layered visual effect to the built form of the city when viewed both from within Central Sydney and from without.

The fourth purpose is to reduce amenity impacts on neighboring buildings. This purpose is inconsistent with the principle of efficient use of land. Each development should provide for its own amenity and not “borrow” amenity from adjacent sites.

5

Example SVF tests

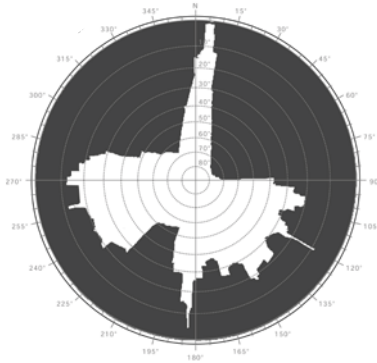

Existing Condition

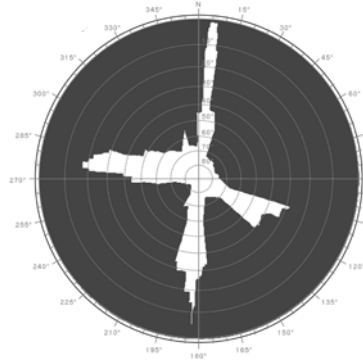

25m Podium, 8m Setback

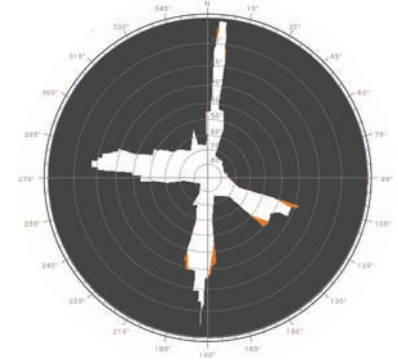

45m podium, 8m Setback

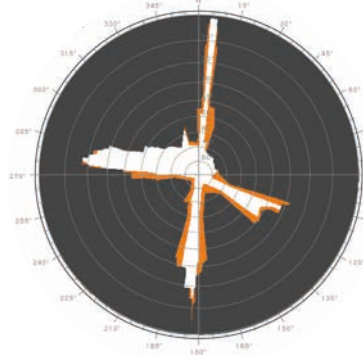

45m podium, 0m Setback

D_56

Sky View Factor Analysis

Point 1

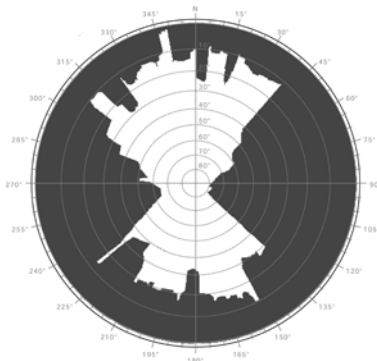

Existing Condition

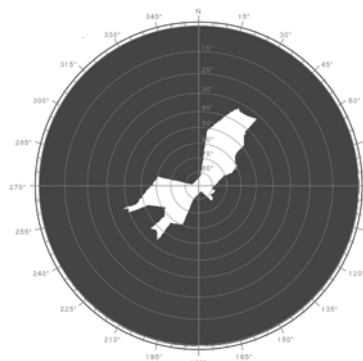

25m Podium, 8m Setback

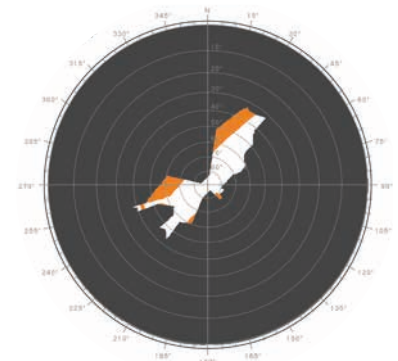

45m podium, 8m Setback

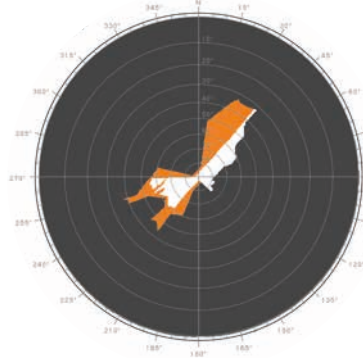

45m podium, 0m Setback

D_57

Sky View Factor Analysis

Point 2

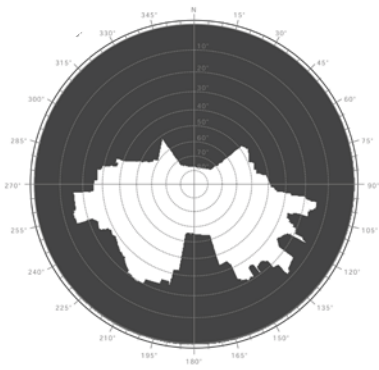

Existing Condition

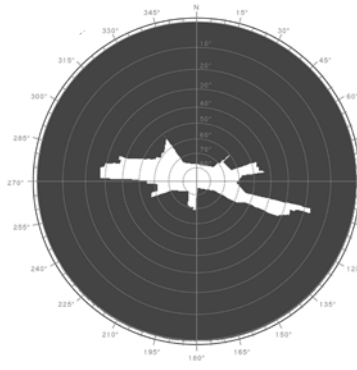

25m Podium, 8m Setback

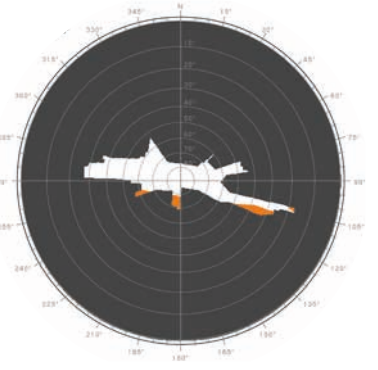

45m podium, 8m Setback

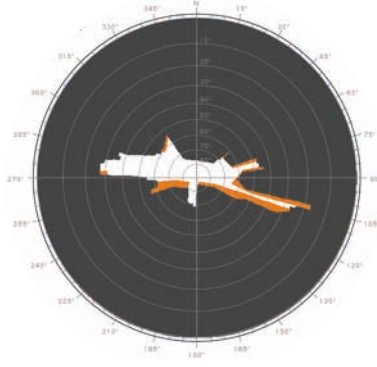

45m podium, 0m Setback

D_58

Sky View Factor Analysis

Point 3

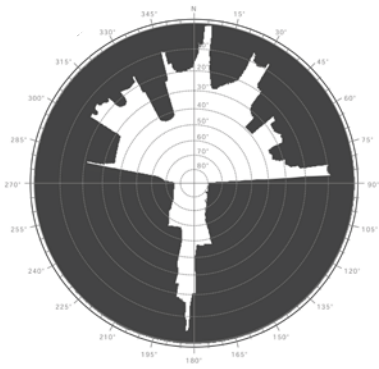

Existing Condition

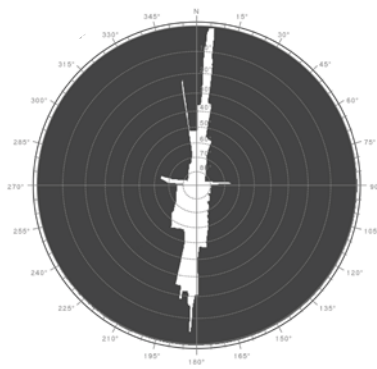

25m Podium, 8m Setback

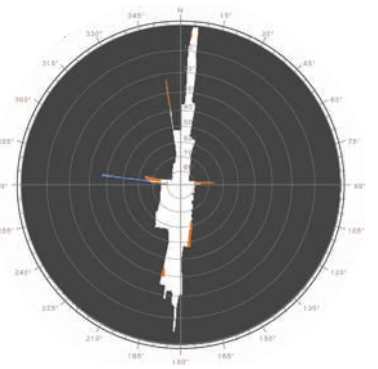

45m podium, 8m Setback

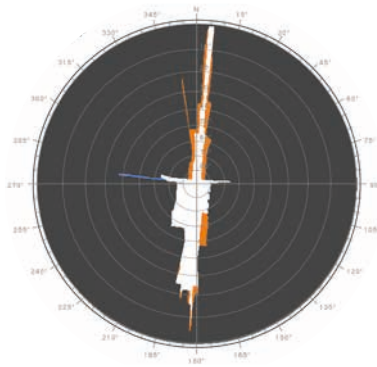

45m podium, 0m Setback

D_59

Sky View Factor Analysis

Point 4

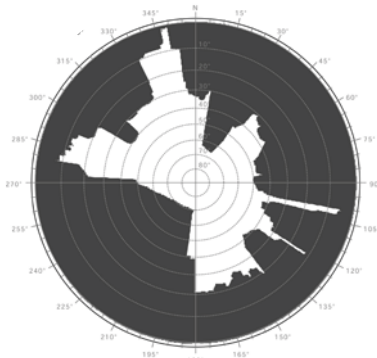

Existing Condition

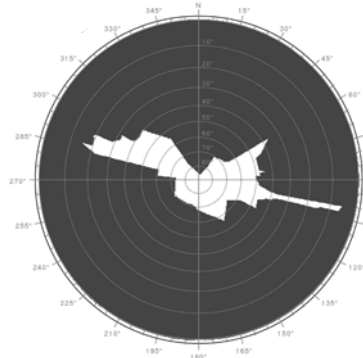

25m Podium, 8m Setback

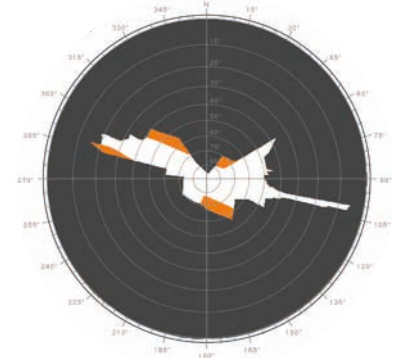

45m podium, 8m Setback

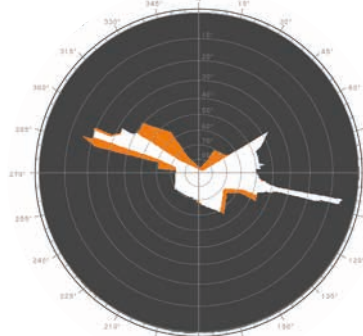

45m podium, 0m Setback

D_60

Sky View Factor Analysis

Point 5

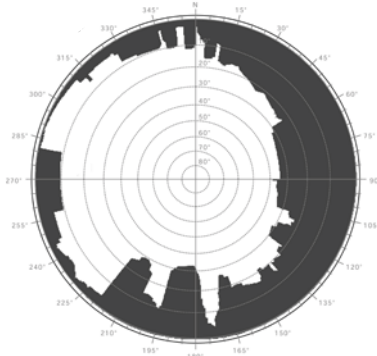

Existing Condition

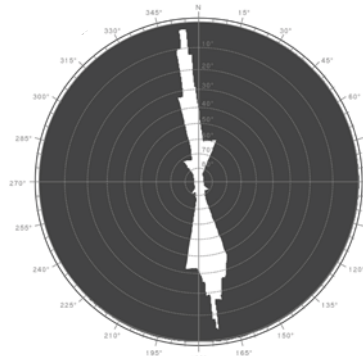

25m Podium, 8m Setback

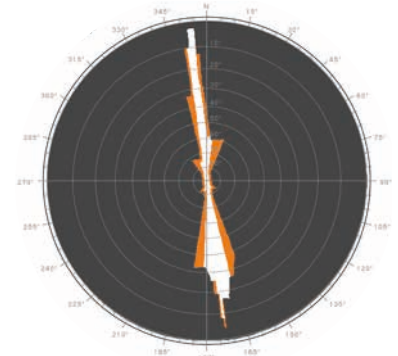

45m podium, 8m Setback

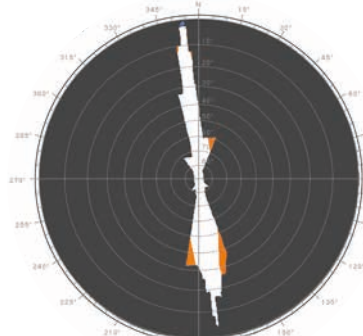

45m podium, 0m Setback

D_61

Sky View Factor Analysis

Point 6

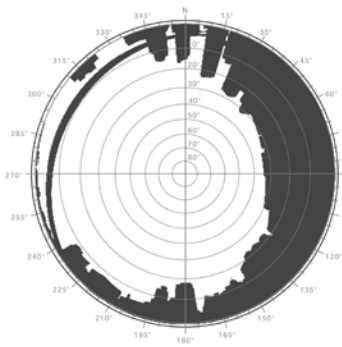

Existing Condition

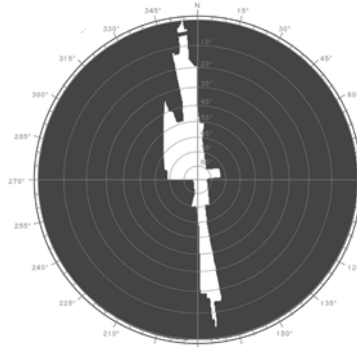

25m Podium, 8m Setback

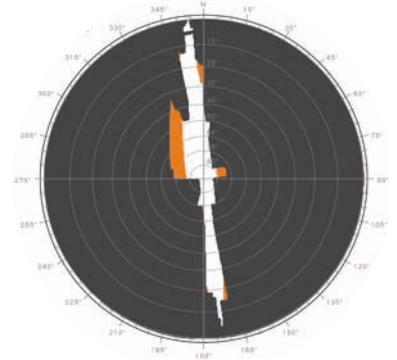

45m podium, 8m Setback

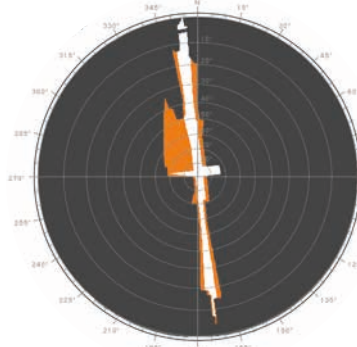

45m podium, 0m Setback

D_62

Sky View Factor Analysis

Point 7

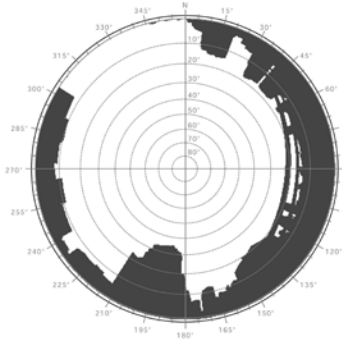

Existing Condition

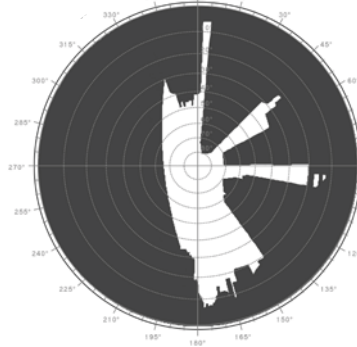

25m Podium, 8m Setback

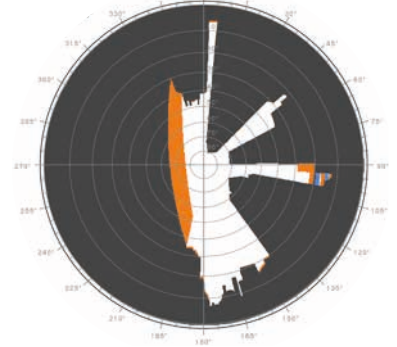

45m podium, 8m Setback

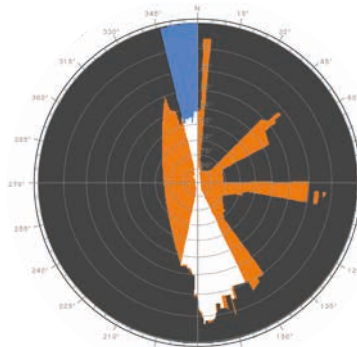

45m podium, 0m Setback

D_63

Sky View Factor Analysis

Point 8

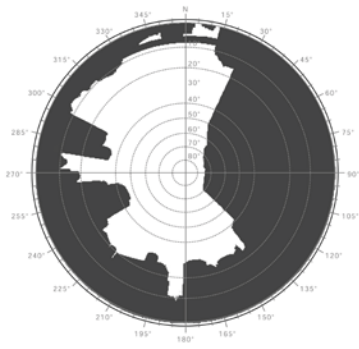

Existing Condition

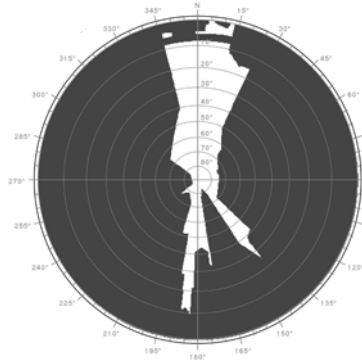

25m Podium, 8m Setback

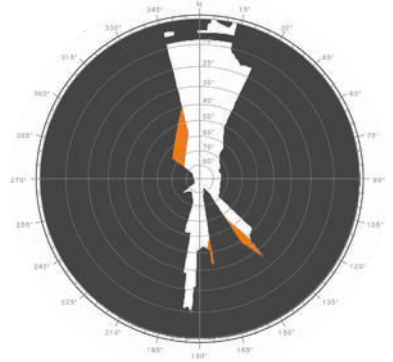

45m podium, 8m Setback

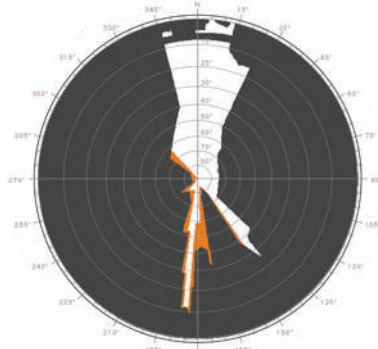

45m podium, 0m Setback

D_64
 Sky View Factor Analysis
 Point 9